

# CENTRIFUGAL PUMP COOLING AND LUBRICANT APPLICATION— A “BEST TECHNOLOGY” UPDATE

by

**Heinz P. Bloch**

**Consulting Engineer**

**Process Machinery Consulting**

**West Des Moines, Iowa**



*Heinz P. Bloch is a Consulting Engineer whose 45-year professional career included long-term assignments as Exxon Chemical's Regional Machinery Specialist for the United States. He is the author of 14 comprehensive books and more than 300 technical papers or similar publications dealing with machinery reliability improvement and maintenance cost reduction issues.*

*Mr. Bloch graduated from the New Jersey Institute of Technology with B.S. and M.S. degrees (cum laude) in Mechanical Engineering. He is an ASME Fellow and maintains registration as a Professional Engineer in the States of New Jersey and Texas. He is the Equipment/Reliability Editor of the monthly publication Hydrocarbon Processing and has conducted hundreds of technical courses on all six continents.*

## ABSTRACT

Process pumps experience widely different operating times to failure. U.S. refineries achieve pump mean-times-between-failure (MTBFs) ranging from less than three years to in excess of eight years. While the importance of pump hydraulic design seems well understood, insufficient attention has been given to important issues of bearing lubricant selection, protection of the oil against contaminant ingress, and optimized application of the lubricant. Bearing cooling issues are addressed and both feasibility and potential monetary value of lube-related energy conservation on pumps with static oil sumps are authoritatively documented. However, while this presentation may not be good news to everybody, it highlights only those concepts that are well-proven and understood by best-of-class performers. As such, these issues merit serious consideration and follow-up by plants that are trying to catch up.

## INTRODUCTION

Most process pumps in use today are not receiving optimal lubrication. For a certainty, millions of dollars are squandered each year because of misunderstood lubricant selection, application, and allowable lube oil temperatures in pump bearings. As an example and to this day, thousands of pump bearing housings are being cooled by way of water jackets or cooling coils immersed in the oil. Meanwhile, thousands of identical pumps operating under the same, or even more adverse fluid conditions elsewhere had their cooling water connections removed years ago. Indeed, bearing life extensions are the norm whenever cooling the bearing environment is discontinued in centrifugal pumps.

Also, some bearings are “flooded,” i.e., lubricated by oil reaching the center of the lowest rolling element, while in others the oil level *must* remain well below even the bottom periphery of the bearing outer ring. It is obvious that oil must be fed to the latter bearings by means of oil rings or similar devices. Yet, not every

user, and not even all pump manufacturers, realize that one feed method may prove demonstrably superior to another. If oil rings were supplied with your pumps, how can you be certain they represent best available technology? Why are oil rings avoided by reliability-focused plants? The explanations will be found in this presentation.

Finally, some plants adhere to the practice of using a medium-viscosity ISO Grade 68 or VG 100 lube oil. Meanwhile, a neighboring plant employs ISO VG 32 lubricants for the same equipment. Again, should there be a preferred viscosity, or type of oil, for pump bearings? These are important issues and their satisfactory resolution will save pump users large amounts of money. This presentation is aimed at sorting out the differences and should give solid guidance to reliability-focused users. A reliability-focused user is one who will not accept repeat failures and who strives to match the equipment reliability performance of the best and most profitable competitors. That implies digging deeply into the more elusive underlying causes, which is exactly what this presentation will help to accomplish.

## WHY COOLING EVEN API 610 REFINERY SERVICE PUMPS MAY BE COUNTERPRODUCTIVE

Many refinery pumps handle flammable fluids. With safety and reliability of foremost importance in these services, these important concerns led to the development of the API 610 Standard (2003). Although not a legally binding document, this well-known industry standard covers the basic requirements that impart reliability to process pumps. API 610 (2003) is obviously of great importance in heavy and severe duty pump applications.

One of the most severe pump applications is “hot oil.” This term covers 300°F/149°C to 750°F/399°C service temperatures, which tend to create critical pump conditions. Thermal expansion of hot pump components is a fact, and pump mountings must maintain shaft alignment at these elevated temperatures. Casing centerline support, without a separate support for the bearing housing, is normally used to address this concern. But are the bearing housings really hot, and do the “hot pump” bearing housings need cooling?

Intuition may lead to the belief that the bearing housings of hot oil pumps must be cooled. The tradition followed by many pump users, design and installation contractors, and even some pump manufacturers is often in line with this intuition. However, both intuition and tradition are wrong in this instance. While a certain amount of heat will, of course, migrate from the impeller region toward the bearings, the incremental temperature increase of “uncooled” versus “traditionally cooled” bearings is quite manageable. In conventional process pumps and at rolling element bearings mounted with proper fit, this incremental temperature has never exceeded 100°F (56°C). In this context, proper fit means obtaining bearing inner-ring-to-shaft fits generally below the midpoint of the bearing manufacturer's recommended shaft interference fits.

As will be seen later, there are technical and economic advantages associated with deleting cooling water from rolling element

bearing housings. In any event, having deleted cooling water and to accommodate this relatively moderate temperature increase of less than 100°F (56°C), reliability-focused pump users successfully apply thicker, more viscous oils for rolling contact bearings in pumps. These are generally ISO VG 68 synthetics or, in rare cases, VG 100 mineral oils, although high-grade synthetic VG 32 lubricants may well represent the best choice at locations using dry sump oil mist and placing a premium on energy efficiency. It should again be noted that, for sump-lubricated pumps, cooling is simply not needed. This is why, since the early 1970s, reliability-focused users have discontinued cooling rolling element bearings in pumps (Bloch, 1998). To date, this discontinuation practice has been successfully followed regardless of the temperature of the media being pumped.

These findings and recommendations harmonize with tables published by a leading bearing and seal manufacturer in an application handbook in 1995 (Table 1). However, it is important to note that:

Table 1. Recommended ISO Viscosity Grades (Mineral Oils).

Bearing Operating Temperature °C (°F)	Ball and Cylindrical Roller Bearings	Other Roller Bearings
70 (158)	VG 46	VG 68
80 (176)	VG 68	VG 100
90 (194)	VG 100	VG 150

- These guidelines strictly pertain to rolling element bearings; they are not intended for sleeve bearings.
- The bearing manufacturer is careful not to comment on the acceptability of any specific lube delivery or application method for these lubricants.
- The bearing manufacturer does *not* recommend ISO Grade 32 mineral oils in Table 1 for rolling element bearings.
- The bearing manufacturer's guidelines pertain to *mineral* oil. Independent research by a major multinational petrochemical and refining company (in 1979) confirmed that premium grade synthetic VG 100 is the "protection-equivalent" of mineral oil VG 150; premium grade synthetic 68 is the "protection-equivalent" of mineral oil VG 100; premium grade synthetic VG 32 is the "protection-equivalent" of mineral oil VG 68.

#### UNDERSTANDING THE NEGATIVE EFFECTS OF BEARING COOLING

Using cooling water jackets can prove disastrous to bearing life. Cooling water jackets that only *partially* surround bearing outer rings have often restricted the uniform thermal expansion of operating bearings and have been known to force bearings into an oval shape. There have been many instances where, as a result, bearing operating temperatures were *higher with* "cooling," and *lower after* the cooling water supply was disconnected and the jackets left open to the surrounding atmosphere (Bloch, 1998).

Similarly, cooling water flowing through a coil immersed in the lube oil has also been known to cause problems. Adherence to this "traditional" cooling method very often invites vapor condensation in bearing housings. Unless the bearing housings are hermetically sealed (Bloch and Budris, 2004), moist air fills much of the bearing housing volume. Upon being cooled, the air sheds much of its water vapor in the form of liquid droplets. Since this condensate causes the lube oil to degrade, cooling the bearing environment can be indirectly responsible for reduced bearing life in pumps. Regrettably, some pump manufacturers and installation contractors

have been painfully slow in endorsing the deletion of cooling water. Others have been equally slow advocating superior synthetic lubricants and certain highly advantageous application methods. Where cost-justified, advantageous application could refer to pure oil mist ("dry sump") for both effective lubrication of operating pumps and, especially, the protection of nonrunning pumps against harmful environments (Bloch and Shamim, 1998).

In any case, for rolling element bearings that are properly installed and loaded per manufacturer's allowable guidelines, cooling the oil is neither necessary nor helpful. Instead of following misguided tradition, and for bearing housings from which cooling liquid has been removed, reliability-focused users choose the right synthetic base stock (generally diester or diester/polyalphaolefin [PAO] blend formulations; Bloch, 2000). Also, reliability-focused users select the correct viscosity and, as will be shown later, avoid the use of oil rings because of their serious limitations at today's higher operating speeds.

#### COOLING WATER MAY STILL BE NEEDED FOR SLEEVE BEARINGS

It is intuitively evident that some heat is being conducted to pump bearings. Moreover, oil shear in bearings produces heat. Therefore, in many applications involving sleeve bearings, the oil may indeed have to be kept cool through the use of cooling water jackets that surround the bearings, or by cooling water coils immersed in the oil. Cooling thus tends to ensure that the correct lube oil viscosity is being maintained. Nevertheless, there are many sleeve bearings that will simply not require cooling water. As explained in Bloch (1998), they can be identified by temporarily shutting off cooling water in a controlled test during which the steady-state oil temperature of a premium ISO Grade 32 synthetic is observed to remain below approximately 170°F (77°C).

The correct oil viscosity is needed for reliable lubrication and also for dependable oil application. In other words, an oil ring will not behave the same way in lubricants with substantially different viscosities. The oil film thickness developed in the bearing differs for different oil viscosities. A low viscosity lubricant is required and means of cooling the lubricant may be needed for close viscosity control. Also, a rotor at rest may cause the oil film to be "squeezed out" from the space between journal and bearing bore. Upon startup, lube oil must immediately be supplied so as to provide a separating film between shaft and sleeve bearing. With this oil typically supplied by an oil ring, oil of reasonably constant viscosity is needed to allow the ring to rotate properly. Suffice it to say that, as recently as 2004, a misguided refinery allowed sleeve bearing oil sump viscosities to reach the equivalent of ISO VG 150. The consequences proved very costly, and especially so on bearings that depended on proper functioning of oil rings.

#### OIL LEVELS AND OIL APPLICATION METHODS

Allowing lube oil to reach the center of the lowermost bearing ball of, say, a 70 mm bearing is acceptable at 1500 and 1800 rpm. If used for rolling element bearings at these—for pumps—relatively moderate speeds, oil rings serve only to keep the oil well mixed and to thus avoid hot oil to "stratify" and float to the top. On the other hand, oil rings in sleeve bearings (shown in Figure 1) must physically feed, or transport oil into the bearing. The dimensions typically used for oil rings in either sleeve or rolling element bearings are given in Figure 2. Ring diameters can vary from 1.5 to 2.2 times shaft diameter. A multiplier of 1.7 is shown here; it represents an experience-based optimum, as does the 30-degree included angle.

Unlike oil rings, flinger discs are *only* used on equipment furnished with rolling element bearings. On slow and moderate speed pumps where the oil level reaches the center of the lowermost ball (Figure 3), these flinger discs are primarily used to keep the oil mixed; it can thus be said that they serve as the functional equivalent of an oil ring under these circumstances.

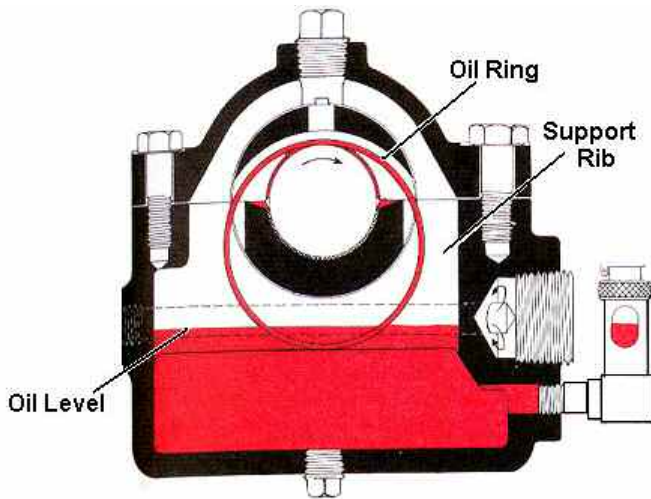

Figure 1. An Oil Ring Transfers Lubricant from Static Sump to Bearing Bore Region.

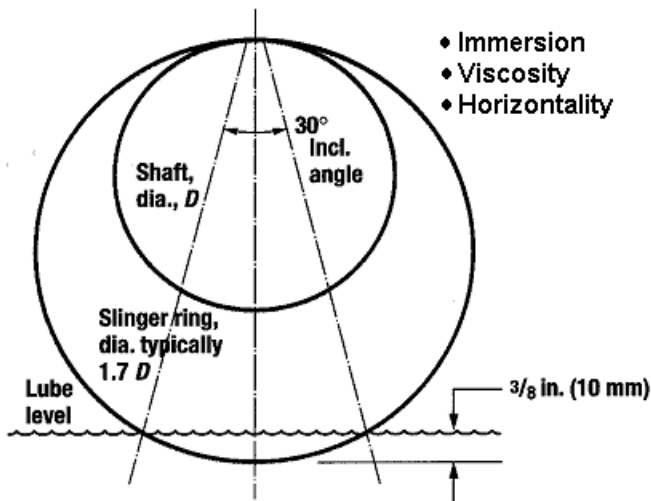

Figure 2. Oil Rings (“Slinger Rings”) Are Affected by Shaft Attitude, Depth of Immersion, Lubricant Viscosity, Ring Concentricity, and Finish.

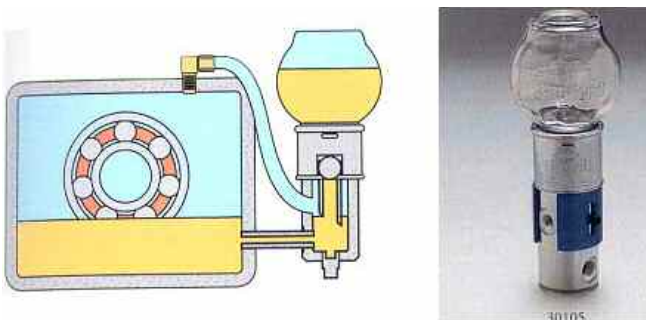

Figure 3. Balanced Constant Level Lubricator. Location at right would be correct for CCW shaft rotation, i.e., “up-arrow” near assembly. (Courtesy Trico Mfg. Co.)

There are many flinger disc geometries (Figure 4), and in higher speed equipment where the oil level must not be allowed to even reach the lowermost periphery of the rolling element bearing, these flinger discs must pick up oil and fling it into the bearing. At least one U.S. vendor and many European pump manufacturers have been using flinger discs for several decades.



Figure 4. “Trimmable” Flinger Disc—A superior replacement for oil rings in equipment furnished with rolling element bearings. (Courtesy Trico Mfg. Co.)

There never exists reasonable justification for oil levels higher than the center of the lowermost rolling element of the bearing, as illustrated in Figure 3. Higher-than-needed levels only increase “churning” and cause bearing oil temperatures to rise. This can be seen by comparing the oil temperature trace obtained for an oil level going through the center of the lowermost ball, Figure 5, with the temperature trace for an oil level touching the lowermost periphery of the pump shaft, Figure 6. If oil levels fluctuate so much that the user feels compelled or justified to increase lube oil levels to above the top of the lowermost bearing, the reasons can often be found in installation deficiencies and selection flaws. Chief among these flaws is not observing the up-arrow location of constant level lubricators (Figures 3 and 7), or using an unbalanced constant-level lubricator, Figure 7, where only a balanced version, Figure 3, will give satisfactory long-term results. These issues are related to Bernoulli’s Law and are thoroughly explained in Bloch and Budris (2004).

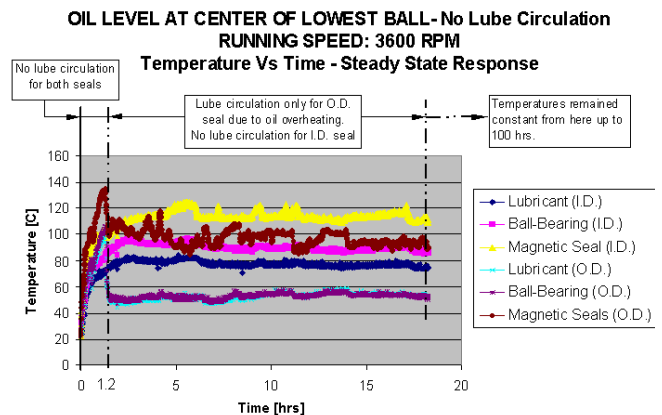

Figure 5. Temperature Profiles in a Bearing Housing with ISO Grade 32 Synthetic Oil at the Center of Lowermost Ball. (Courtesy Urbiola Soto, 2002)

As related in Figures 5 and 6 and further described in Urbiola Soto (2002), the bulk oil temperature existing in a somewhat typical bearing housing equipped with a single-face magnetic seal and using ISO Grade 32 synthetic lubricant was found to be 75°C (167°F) above ambient with the oil level at the center of the lowermost ball (Figure 5). When the oil level was allowed to reach the bottom of the pump shaft, the measured bulk oil temperature was 85°C (185°F) above ambient and rising. This actually prompted the researcher to stop the test (Figure 6).

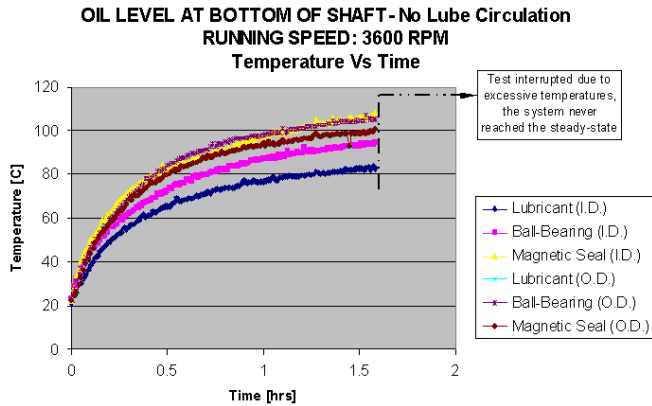

Figure 6. Temperature Profiles in a Bearing Housing with ISO Grade 32 Synthetic Oil Reaching Bottom of Shaft. (Courtesy Urbiola Soto, 2002)

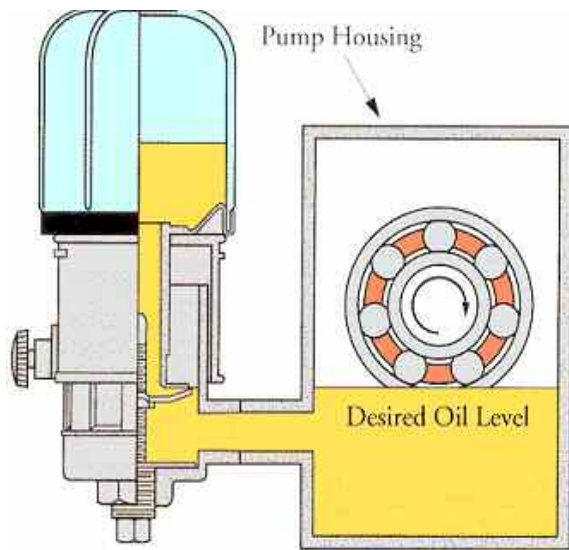

Figure 7. Unbalanced Constant Level Lubricator Installed at “Up-Arrow” (Left) Location. (Courtesy Trico Mfg. Co.)

Notwithstanding the test results described in Urbiola Soto (2002) and relating to operation at 3600 rpm, field experience under load shows that at 3000 and 3600 rpm allowing the lube oil to reach the center of the lowermost rolling element is likely to result in excessively high lube oil temperatures. The oil levels of pumps operating at 3000 and 3600 rpm are, therefore, customarily set well below the bottom of the lowermost ball or rolling element. Mechanical means must now be employed to feed, lift, spray, or splash the lubricant into pump bearings. Whereas at lower speeds the function of an oil ring or flinger disc was confined to just mixing the oil, loose oil rings (“slinger rings”), Figures 1 and 2, or—preferably—flinger discs, Figure 4, must now serve a more important purpose. They must now either create a dispersion of oil droplets in air, or must in other ways deposit lubricant into the bearings of 3000 or 3600 rpm pumps.

#### WHY OIL RINGS SHOULD BE AVOIDED

Four factors—shaft horizontality, oil viscosity, depth of immersion in the lubricant, and ring concentricity—have an effect on the operating stability of oil rings. These four factors inevitably vary from pump to pump and day to day. Indeed, using even the most advantageous laser-optic alignment devices, alignment is usually obtained by placing shims under the supports of either the driver or driven machine. As a result, true horizontality of the entire shaft system is rarely achieved and loose oil rings simply tend to

run “downhill.” Oil viscosity is changing with temperature and also with the degree of contamination. (It should be noted that bearing temperatures and thus oil temperatures and operating viscosities differ with different shaft fits, and even different amounts of piping-induced housing deflection.)

Depth of immersion is not always closely controlled, and neither oil ring concentricity nor quality of machined surfaces consistently meet the expectations of knowledgeable maintenance practitioners (Urbiola Soto, 2002). Quite obviously, the four factors can exist in an almost endless combination of variables. Oil rings, therefore, have frequently been judged an undue risk and are usually avoided by reliability-focused pump owners.

There is ample proof that unstable oil rings bounce around. They slip on the shaft and often touch the inside of a bearing housing. They then abrade, and wear debris contaminates the lube oil (Urbiola Soto, 2002). On numerous occasions, ring wear has been observed in the field not only by users, but also by pump manufacturers. Such wear typically causes the lube oil to change to a gray color. Placing some of this contaminated oil on tissue paper and holding it against the sunlight will make the wear particles sparkle. Of course, an analytical laboratory could also verify the presence of oil ring debris. In any event, many oil rings that start out with slightly chamfered edges end up with sharp edges after a few months of what must have been unstable operation.

Different oil ring materials and configurations have occasionally been tried and advocated. Concentric grooves machined in the oil ring will deliver more oil (Bloch and Budris, 2004; Wilcock and Booser, 1957), but have at best negligible effect on ring bounce. In the 1990s, a pump manufacturer experimented with oil rings made of high performance polymers and advocated the use of ISO Grade 46 lubricants instead of either the lighter or heavier grades typically stocked at users’ facilities (Bradshaw, 2000). While laboratory results may have been encouraging, these experiments did little to cure the fundamental shortcomings of oil rings in real-world, field-installed situations.

As an experience-based rule, authoritative texts (Wilcock and Booser, 1957) caution that shaft velocities as low as 2000 fpm (~10.16 m/s) might represent the safe, or practical, field-installed (meaning nonlaboratory) limit for many oil rings. At 3600 rpm, this limit infers a maximum shaft diameter of approximately 2.125 inches (~55 mm). It represents a “DN”-value of 7650, where DN is the product of shaft diameter (inches) and speed (rpm). Corroborating values of practical limits are based on the experience of a major multinational petrochemical and refining company. These values can be found in a training course based on the lube marketing literature of a major oil company (Thibault). It explains that, unless laboratory conditions are maintained, oil rings tend to become unstable whenever DN exceeds the region from 6000 to perhaps 8000. At 3600 rpm, even a 65 mm (2.56 inch) diameter shaft would thus operate at  $DN = 9200$ —quite obviously in the potentially troublesome region.

Always recall that we are expected to learn from the experience of others. We should avoid having to establish our risk tolerance through costly and perhaps time-consuming trial and error. This is especially true when low-cost alternatives are known to exist and can demonstrably reduce failure risk. When asked to be more definitive, i.e., to clearly state when rings could be used, and when or where they could not be used, we must again point to the fact that shaft horizontality, depth of immersion, oil viscosity, ring and shaft surface finishes, and ring concentricity interact in various ways. Years of experience, three authoritative references, and the intense quest to avoid the reliability risks encountered under *actual plant operating conditions* led to the formulation of these DN-limits. It also pointed to flinger discs as one possible solution.

#### WHY RELIABILITY-FOCUSED USERS RECOMMEND FLINGER DISCS

Since flinger discs are secured to the shaft, they are not subject to the compounded influences of shaft horizontality, oil viscosity,

depth of immersion, and ring concentricity. They are a vast improvement over oil rings and are available in many pump models presently marketed by United States and European manufacturers. Bloch and Budris (2004) contains a page from a 1960s vintage catalog issued by a then prominent major U.S. pump manufacturer. The page shows the flinger discs furnished with their pumps and states, rather pointedly, “anti-friction oil thrower ensures positive lubrication and eliminates the *problems associated with oil rings.*”

Indeed, oil rings were problematic in the 1960s and, 40 years later, are still known to present problems in many field installations. Fortunately, “trimmable” flinger discs are available as a cost-effective upgrade and retrofit option. (“Trimmable” implies that the elastomeric disc can be easily trimmed to the required diameter. The elastomer will fold into an umbrella shape during insertion through a narrow bearing housing bore and will then snap back into its regular disc shape.)

Figure 4 depicts a trimmable retrofit flinger disc. In 2003 and 2004, testing was done on a Viton® disc configuration picking up the oil from below the lowermost periphery of bearing. The results of this testing are shown, in Figures 8 through 11, for ISO Grade 32 and 68 lubricants at two different speeds. In each case, the temperature behavior was compared against operation with the flinger disc removed and lube oil reaching the center of the lowermost bearing ball. It can be seen that, at higher pump speeds, lowering the oil level and using the trimmable flinger disc will reduce oil temperatures. Reduced oil temperatures will slow down the rate of oil oxidation (Royal Purple Ltd., 2000-2004) and tend to more closely maintain lubricant viscosity. However, it should be noted that with premium synthetic lubricants and operation at typical process pump speeds, the rate of oxidation is extremely slow. In that case, concern over oxidation issues on hermetically closed pump bearing housings may be somewhat academic.

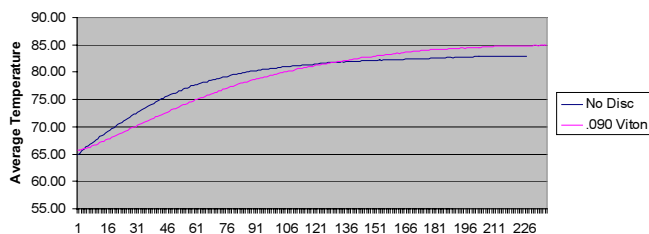

Figure 8. 1800 RPM, Temperature Versus Time, ISO Grade 32 Oil Level Reaching Center of Lowermost Bearing Ball, No Flinger Disc; Also, oil level not reaching bearing, oil picked up by flinger disc. (Courtesy Trico Mfg. Co.)

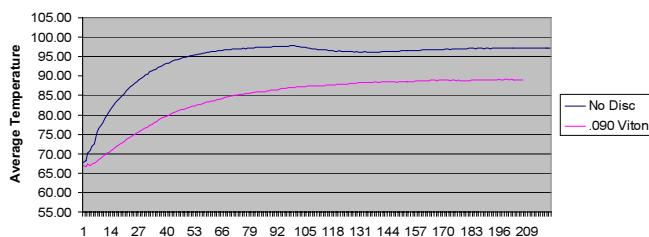

Figure 9. 3600 RPM, Temperature Versus Time, ISO Grade 32 Oil Level Reaching Center of Lowermost Bearing Ball, No Flinger Disc; Also, oil level not reaching bearing, oil picked up by flinger disc. (Courtesy Trico Mfg. Co.)

PURE OIL MIST LUBRICATION  
AND ISO GRADE 32 SYNTHETIC LUBES

Before describing how leading reliability-focused plants can be eminently successful in reducing both energy consumption and maintenance costs, there are three important points to be made.

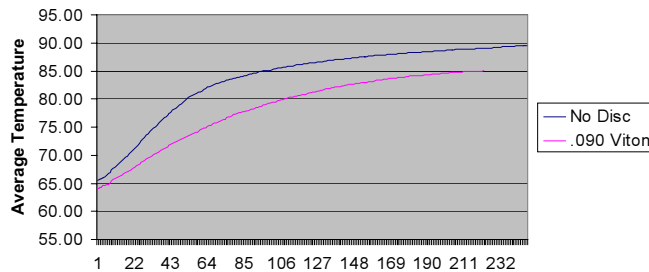

Figure 10. 1800 RPM, Temperature Versus Time, ISO Grade 68 Oil Level Reaching Center of Lowermost Bearing Ball, No Flinger Disc; Also, oil level not reaching bearing, oil picked up by flinger disc. (Courtesy Trico Mfg. Co.)

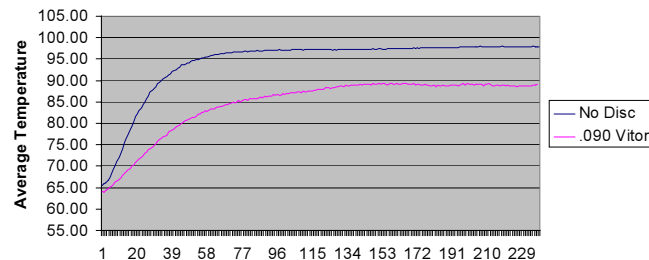

Figure 11. 3600 RPM, Temperature Versus Time, ISO Grade 68 Oil Level Reaching Center of Lowermost Bearing Ball, No Flinger Disc; Also, oil level not reaching bearing, oil picked up by flinger disc. (Courtesy Trico Mfg. Co.)

First, an exceedingly well-researched paper on the “Effects of Synthetic Industrial Fluids on Ball Bearing Performance” (Morrison, et al., 1980) indicates that a readily available synthetic lubricant, having a viscosity of 32 cSt at a temperature of 313K, offered long-term contact surface protection. This protection was found to be equivalent to that of a baseline mineral oil with a viscosity of 68 cSt and was verified to be such that it did not reduce bearing service life below the theoretically predicted levels. However, the same good wear protection could *not* be achieved with a reduced viscosity *mineral* oil. The use of the lower viscosity *synthetic* lubricant could, and did, provide energy savings that are hard to ignore in a cost and reliability-focused plant environment.

Second, since 1980, additional means of achieving energy savings have become available in the form of superior additives technology. While important and ever-relevant, the referenced ASME paper (Morrison, et al., 1980) was narrowly focused and strongly structured around viscosity and base oil (diester). Modern additives technology further strengthens wear protection and offers reduced energy consumption with other synthetic base oils and without requiring reductions in viscosity (Royal Purple Ltd., 2000-2004).

Third, while energy conservation is not everyone’s priority, industry in some countries is nevertheless being penalized by regulatory mandate if they are not using best available technologies. Perhaps this segment of this presentation will be helpful to them.

Needless to say, in the years since the statements relating to energy savings were made and these important findings published in Morrison, et al. (1980), energy prices have escalated and equipment failures have become more costly than ever. Plant resources and budgets have shrunk, and industry is looking for asset preservation. In essence, the topic has taken on considerable added importance. Therefore, a thorough analysis of the full significance of the above research and its findings is long overdue. It should be noted that the three coauthors of Morrison, et al. (1980), F. R. Morrison, James Zielinski, and Ralph James, represented the combined knowledge of one of the world’s most experienced bearing manufacturers, a leading tribology scientist, and the chief

machinery engineer of one of the world's largest multinational chemical companies. Appropriately, then, this presentation segment recaps and incorporates the findings, and many of the comments and quotes, found in this very important ASME paper. Also, it draws inferences from more recent findings regarding the equivalent effectiveness of PAO-based synthetic lubes containing advanced additives.

### SYNTHETIC LUBES REDUCE FRICTION

Energy savings through conscientiously applying tribology know-how are not a new concept (Pinkus, et al., 1997). However, prior to the work of Morrison, Zielinski, and James, little had been documented on the effects of synthetic fluids on the frictional power losses of industrial equipment. Because synthetic fluids are chemically different from mineral oils, one might expect effects that go beyond those attributable to viscosity relationships alone. Indeed, lubricant properties and application methods also influence lubrication effectiveness and the frictional torque to be overcome.

On a purely hypothetical level, the potential cost savings through power loss reduction appear to be quite substantial. Current estimates assign 31 percent of the total U.S. energy consumption to industrial machinery. It has also been estimated that 5 percent of the mechanical losses of these machines can be recovered through a combination of improved equipment design and lubricant optimization.

As was pointed out in Villavicencio (2002), the application of pure oil mist can be a valuable component of such an optimization approach. Interestingly, the three researchers alluded to solutions based on a "tribothermodynamic integrated approach" (TTD/IA).

Although not using the same terminology, their joint paper illustrated the general feasibility and validity of TTD/IA on purely economic grounds. It is in these areas where the substitution of 2003-vintage cost and economic considerations will prove worthy of attention. This review seeks to accomplish this updating.

### METHODOLOGY APPLIED IN DETERMINING MERITS OF SYNTHETIC LUBES AND PURE OIL MIST

The research work of Morrison, Zielinski, and James was conducted considering three different modes of lubrication: air-oil mist and static oil sump, both typically used in conventional pump applications, and circulating oil, which is required for high-load laboratory tests performed by bearing manufacturers.

TTD/IA was being used to evaluate these three modes of lubricant application. The tests were separated into one sequence that used two different viscosities of mineral oil, and a second sequence that used two different viscosities of a diester-based synthetic lubricating fluid.

The summary of bearing test data is presented without changing the results originally published (refer to Figures 12 through 14—based on Royal Purple Ltd., 2000-2004), and in absolute as well as relative values for both ISO Grade 68 mineral and ISO Grade 32 synthetic lubricants. Bearing test data were acquired in the form of temperature and power loss reductions.

### RESEARCH RESULTS RESTATED

The tests were conducted on thrust bearings; the researchers selected a test load of 8.9 kN (2000 lbf). Three changes were involved and their effects investigated:

- A lower viscosity oil was used.
- Mineral oil was replaced with synthetic oil.
- Dry sump oil mist was applied instead of a static sump.

Using relative values, Morrison, et al. (1980), presented the test results in terms of an average reduction of two variables:

- Temperature rise reduction: 35 percent
- Power reduction (kW-loss): 38 percent

Avg. Temp Rise (K)		
Load = 8.9 kN (2000lbf)	Oil Sump	Oil mist
MIN 68	66	48
SYN 32	52	43

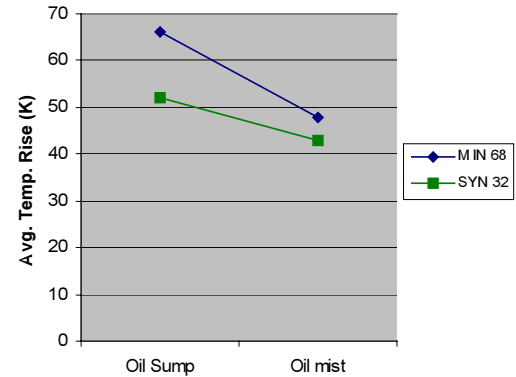

Change	$\Delta T$	Total reduction
Sump: MIN 68 to SYN 32	-14	21%
Mist: MIN 68 to SYN 32	-5	10%
Sump: MIN 68 to Mist MIN 68	-18	27%
Sump: SYN 32 to Mist SYN 32	-9	14%
<b>Sump: MIN 68 to Mist SYN 32</b>	<b>-23</b>	<b>35%</b>

Figure 12. Temperature Relationships for Synthetic Lube Oil and Different Lube Oil Application Methods.

As indicated in Morrison, et al. (1980), and shown below, the combined averages were 37 percent. The researchers found that the 37 percent average could be broken down as follows:

- From mineral 68 to synthetic 32 (type change and viscosity change, hence two changes): 12 percent (or 35 percent of overall)
- From oil sump to oil mist, one change: 24 percent (or 65 percent of overall)
- Total, all three changes: 37 percent (or 100 percent of overall)

To restate, the total reduction in bearing frictional torque amounted to 37 percent. Relabeling (normalizing) this percentage and assigning it the value 100 "saved units," the combined type change and viscosity change contributed 35, and the oil-sump-to-oil-mist change contributed 65 "saved units." Visualization of this breakdown is important because TTD/IA coincides with the research findings that a 35 percent reduction in temperature rise is achieved by simultaneously implementing three changes, i.e., using a synthetic lubricant, lowering the lubricant viscosity, and switching to dry sump oil mist lubrication. Based on bearing manufacturers' data and the empirical results of four decades of field experience derived from many thousands of centrifugal pumps and electric motor drivers, power loss reductions will track temperature rise reductions.

Ever since bearing and lubrication research was conducted in the 19th century, it has been documented that lowering lubricant viscosity leads to a reduction in frictional losses. Hence, less energy will be consumed. This undisputed fact has led to recent moves by the European auto industry to encourage development of Society of Automotive Engineers (SAE) multigrade "0W30/40"-equivalent automotive lubricants, while the lowest previously available multigrade oils carried the SAE viscosity designation "5W20." Of course, the minimum allowable viscosity must be consistent with the provision of a tenacious and unbroken oil film that is thick enough to preclude metal-to-metal contact.

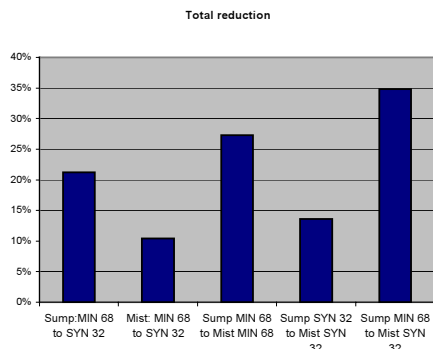

Power loss per bearing (kW)		
L = 8.9 KN (2000 lbf)		
	Oil Sump	Oil Mist
<b>MIN 68</b>	0.271	0.192
<b>SYN 32</b>	0.254	0.169

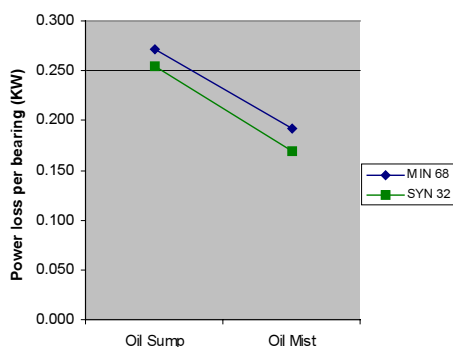

Figure 13. Power Loss Relationships Based on Synthetic Lubricants and Different Lube Oil Application Methods.

Change	Δ Power loss per brg.	Total reduction
Sump: MIN 68 to SYN 32	0.017	6%
Mist: MIN 68 to SYN 32	0.022	8%
Sump: MIN 68 to Mist MIN 68	0.080	29%
Sump: SYN 32 to Mist SYN 32	0.085	31%
<b>Sump: MIN 68 to Mist SYN 32</b>	<b>0.11</b>	<b>38%</b>

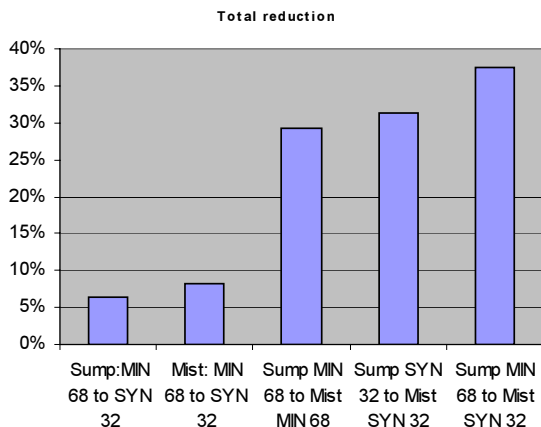

Figure 14. Frictional Power Loss Relationships for Synthetic Lubricants and Different Lube Application Methods.

SYNTHETIC LUBRICANT DESCRIBED

Restating an important point made earlier, using diester base oils is not the only way to achieve energy savings. In excess of one hundred rigorous field studies have shown that properly formulated PAO synthetic lubricants can achieve significant energy savings irrespective of changing the viscosity of the oil.

The findings of Morrison, et al. (1980), were base-oil specific and ignored the influence and contribution that advanced additive chemistry can have on friction and wear. However, since this review must adhere to the aforementioned paper and since the research described by Morrison, Zielinski, and James involved diester oils, the author here is dealing with this type of synthetic fluid only. Suffice it to say that today, in 2005, their statements are known to be equally valid for the widely used PAOs and some other synthetics. The interested reliability professional might request relevant literature and solidly documented field experience data from one or two well-established and highly competent lube formulators and vendors. These data will corroborate the author’s contention that similarly advantageous results have been achieved using PAOs with advanced additive systems.

As to diesters, these comprise a molecular entity substantially different from mineral oil. These synthetic esters of adipic acid and appropriate molecular weight oxalcohols contain an additive package designed to provide thermal oxidation stability, wear protection, rust protection, low foaming tendency, and good demulsibility. They are synthetic oils designed for industrial equipment lubrication with an emphasis on longer drain intervals, cleaner operation, and improved safety. These attributes and properties justify the expectation that in an elastohydrodynamic regime ester fluids would perform substantially better than mineral oils. The studies by Morrison, Zielinski, and James confirmed this to be the case.

Specifically, the results of the entire study established that ISO Grade 68 mineral lubricating fluids are equal in terms of oil film thickness and tenacity to ISO Grade 32 synthetic oils. Given the undisputed energy reduction advantages and additional attributes listed above, it was clearly shown that ISO Grade 68 lubricants are not warranted in the overwhelming majority of pump and electric motor applications found in modern industry. Accordingly, the substitution of ISO Grade 32 synthetic lubricants for ISO Grade 68 mineral oils in a refinery or petrochemical plant is both feasible and recommended. Such substitutions will not incur the risk of increasing the frequency of in-service bearing failures and will, in fact, lead to substantial advantages:

- Premium ISO Grade 32 synthetic oils will perform well over the entire temperature range of pump and electric motor bearings. An exception might be made in those instances where cooling water was removed and where the resulting temperature increase favors the use of ISO VG 68 synthetic lubricants.
- Premium ISO Grade 32 synthetic oils will be suitable for both sleeve bearings and rolling element bearings in the majority of process pumps used today.
- Premium ISO Grade 68 synthetic oils will give at least the same bearing L-10 life as ISO Grade 100 mineral oils. ISO Grade 68 synthetic oils will be more energy efficient than ISO Grade 100 mineral oils.
- Based on the rigorous research conducted by Morrison, Zielinski, and James, there would be demonstrable and measurable energy cost savings using premium grade synthetics instead of film-thickness-equivalent mineral oils.

QUANTIFYING THE ENERGY SAVINGS POTENTIAL

The experimental investigations described in Morrison, et al. (1980), thus established that power losses in rolling element bearings could be reduced as much as 37 percent. The test rig instrumentation established that, for bearings in the typical size range used in 15 hp (11.3 kW) process pumps, 0.11 kW was saved.

Understandably, the small absolute value of 0.11 kW per bearing tends to make this savings appear insignificant. However, petrochemical process pump rotors are typically supported by a double row radial ball bearing and two angular contact ball thrust bearings. Most of these pumps operate at 3600 rpm, have a relatively high self-induced axial load, and are oil mist lubricated. The average pump is driven by an electric motor of an estimated 15 hp (11.3 kW) and its rotor is supported on two grease-lubricated ball bearings.

Morrison, Zielinski, and James correctly pointed out the total number of bearings in a typical electric motor driver and pump set. In general, two motor bearings, two rows of radial pump bearings, and two thrust pump bearings represent a total of 4.8 test-equivalent bearings  $[(4 \times .7) + (2 \times 1) = 2.8 + 2 = 4.8]$ . Therefore, the total savings available from the motor-driven pump set are 4.8 times the single test bearing energy savings of 0.11 kW. It can thus be shown that with the above-mentioned change in lubricants and using oil mist as the application method, power loss reductions of approximately 0.53 kW could be realized in the combined 15 hp (11.3 kW) pump and driver system. This represents a power saving of 4.7 percent—quite in line with the literature (Royal Purple Ltd., 2000-2004).

#### HOW MUCH ARE THESE SAVINGS WORTH?

Assuming that the average pump operates 90 percent of the time, and rounding off the numbers, this difference amounts to energy savings of 4180 kW-hrs per year. At \$0.10 per kWh (a value occasionally reached in countries that impose penalties on the discharge of greenhouse gases by industry), yearly savings of \$418 should be expected. It should be noted that these are realistic expectations in spite of the higher cost of synthetic lubricating fluids. In conventional sump-lubricated pumps, longer drainage intervals are entirely feasible as long as synthetic lubes are utilized and as long as these lubes are kept clean by state-of-the-art bearing housing seals (Figure 15). It is noteworthy that API 610, Ninth Edition (2003), specifically lists the applicability of magnetically activated face seals. It is rather evident and has been explained that these provide the best possible protection against ingress of atmospheric contaminants (Bloch and Budris, 2004).

Item	Description	Material
1	Rotary Seal Face	Tungsten Carbide
2	Rotary Elastomer	Viton® / Aflas® / EPR / Kalrez®
3	Stationary Seal Face	Ant.Car-S/S
4	Stationary Elastomer	Viton® / EPR
5	Outer Body	Stainless Steel
6	Outer Body Elastomer	Viton® / Aflas® / EPR / Kalrez®
7	Shroud	Phosphor Bronze
8	Magnet	Metal
9	Stationary Seal Face	Bronze filled Teflon
10	Stationary Elastomer	Viton® / EPR
11	Circlip	Stainless Steel

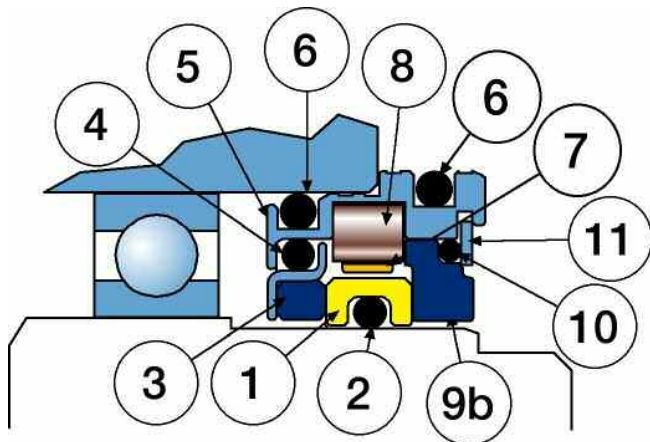

Figure 15. State-of-the-Art Magnetically Energized Dual-Face Bearing Housing Seal. (Courtesy AESSEal, Inc.)

For clean oil, the scheduled oil replacement intervals are typically extended four- or even six-fold; cost avoidance due to these extended drain intervals more than compensates for the incremental cost of synthetic lubricants and hermetic bearing housing seals.

When closed-loop oil mist systems are used, the bearings run cooler and the lubricant remains cleaner and dryer for longer periods than those typically found in conventional oil sump applications. While open oil mist systems typically consume 12 to 22 liters (3.1 to 5.7 gallons) per pump set per year, closed oil mist systems consume no more than 10 percent of these yearly amounts. Again, at these extremely low makeup or consumption rates and compared to the cost of mineral oils, the incremental cost of synthetic lubricants is relatively insignificant.

Considering annual energy saving per 15 hp pump and driver set to be worth \$418, realize that these savings should be multiplied by the number of pumps actually operating in large refineries—850 to 1200. Again using \$0.10 per kWh, annual savings in the vicinity of \$450,000 would not be unusual. A detailed calculation will prove the point:

- Total pump hp installed at the plant = 15 hp × 1000 = 15,000 hp
- Total pump kW installed at the plant = 15,000 × .746 = 11,190 kW
- Total consumption kWh per year, considering 90 percent of 8760 h/yr = 8760 h × .90 = 7884 h/yr = 7884 × 11,190 kW = 88,220,000 kWh/yr
- Total USD value of yearly energy consumption at \$0.10/kWh = \$8,822,000
- Total energy savings = 0.047 × \$8,822,000 = \$414,600

Moreover, there are many refineries that have pumps and electric motor driver sets with average power consumptions in the 30 to 45 hp range. These would obviously use somewhat larger bearings and the likely energy savings would exceed the 0.53 kW value mentioned here. Additional cost savings would accrue and, again, simple ratios will convince reliability-focused plants of the potential savings.

#### REAL LIFE ENERGY SAVINGS OFTEN EXCEED ANALYTICAL CALCULATIONS

While theoretical energy savings can thus be calculated with reasonable accuracy, actual field experience has often shown these calculated estimates to be rather conservative. Synthetic lubes are often delivered in drums with better cleanliness than oils delivered in bulk tankers. Cleaner oils extend bearing life. Closed oil mist systems using hermetic bearing housing seals and applying the mist per API 610 Eighth or Ninth Edition largely preclude the ingress of atmospheric moisture and dust, again leading to inherently longer bearing life. Labor savings are realized when lube replenishing intervals can be extended, or when low-maintenance pure oil mist systems make it possible to discontinue the use of oil sumps altogether. On numerous occasions, experiencing fewer unscheduled pump downtime events has rightly been attributed to properly applied synthetic lubes. Certain tenacious additives have demonstrably assisted in bridging-over the edges of spall marks and similar discontinuities in the raceways of rolling element bearings, thus reducing vibration severity (Bloch, 2000).

The author wishes to again reemphasize that diesters with an ISO viscosity of 32 represent one of two energy-effective and reliability-enhancing tribothermodynamic approaches that have been successful in industry. The other well-proven approach has been developed and documented *after* the studies summarized in Morrison, et al. (1980). This approach employs certain PAO-based, additive-enhanced synthetic lubes that have been shown to reduce energy consumption even though the customary ISO Grade 68 selection was being retained. Putting it another way, experienced



formulators have been able to obtain virtually identical energy savings and bearing reliability improvements while opting to stay with the ISO Grade 68 viscosity oil. Their reasoning has to do with original equipment manufacturer (OEM) warranty and equipment owner’s lube consolidation strategies. Suffice it to say, however, that staying with higher viscosity grade oils (in pure oil mist units) neither negates nor contradicts the findings that properly formulated ISO Grade 32 synthetic lubes would serve equally reliably and would reduce energy consumption even further.

The message is simply that a plant should make every effort to improve the quality of its lubricants and its lubrication practices. Reliability-focused facilities thus make lube management part of an integrated TTD approach. At typically 2 percent, the total cost of lubricants is usually an insignificant part of the overall maintenance budget. Moreover, credits for energy savings alone tend to outweigh the incremental cost of the higher quality, and much preferred, synthetic lubricants.

Clean and dry oils save money. Cleanliness increases both the life of the oil and the life of the equipment. Simply using cleaner and dryer lubricants can increase the life of rolling element bearings four-, or even six-fold (Bloch and Budris, 2004). Being mindful of this fact has prompted some companies to purchase and install oil mist systems. Properly designed and configured oil mist systems used in conjunction with state-of-the-art magnetically energized dual-face bearing housing seals exclude environmental contaminants and will not stress the environment. Although many pump users apply synthetic oils and also bearing housing seals of one type or another, there are cost-effective near-term opportunities for many pump users to establish cleanliness standards for their oil purchases.

Along these lines, here is some experience-based advice: if you cannot purchase clean oil, consider buying equipment that protects and cleans the oil before it is placed in service. The extra time and cost to properly store and handle lubricating fluids will pay big dividends in equipment reliability (Thibault). This, again, is a cost-effective upgrade opportunity that pays back quickly and handsomely.

Energy savings in operating plants can be tracked with simple measurements (amperage, temperature rise, torque). Some plants have convinced themselves of the correctness of this approach by first applying lubrication with a single small oil mist system, containing perhaps four liters (~one gallon) of oil that can be recirculated. The true effects of this approach on maintenance cost avoidance and bottom line profits are then made clear to the organization and the merits of plant-wide oil mist lubrication with ISO Grade 32 synthetics are easily calculated.

In summary, then:

1. For pump and motor bearings lubricated with diester synthetics, the value 0.11 kW power savings per bearing is an absolute number.
2. To achieve power losses of 0.11 kW per bearing, viscosity reduction, substitution of synthetic lube, and oil mist lubrication were implemented.
3. The changes and energy losses related to each are shown in Table 2.

Table 2. Changes and Energy Losses.

Change	KW	Percentage	Total
Oil sump to oil mist	0.08	28%	74%
ISO VG 68 to 32	0.023	8%	21%
Mineral to syn. oil	0.017	2%	5%
Total, 3 changes	0.11	38%	100%

4. It was determined that 74 percent of the power loss reduction corresponds only to the oil mist change and the other two factors represent 26 percent.

5. The calculated power loss of 0.34 kW covers only the pump. If the electric motor (oil mist lubricated) is considered as well, the power loss reduction per pump set will be approximately 0.53 kW.

6. The 0.11 kW reduction per bearing represents an important energy savings of about 4.7 percent in the tribosystem.

7. Measuring energy savings on operating equipment is feasible and should corroborate the findings of Morrison, Zielinski, and James (1980). Theoretical calculations from OEMs are not always precise.

8. In practice, it is possible to reduce bearing frictional power losses by as much as 37 percent when bearing lubrication is optimized.

9. Since testing diester lubes in the late 1970s, virtually identical energy consumption credits and reliability improvements have been demonstrated using ISO Grade 68, PAO-based, additive-enhanced synthetic lubricants.

10. PAO-based ISO Grade 32 synthetic lubricants with well-selected additive formulations will further reduce energy consumption without adversely affecting equipment life and reliability.

Pure oil mist lubrication (Bloch, 1998; Bloch and Shamim, 1998; Bloch, 2001) eliminates the need for either oil rings or flinger discs. No liquid oil sumps are maintained in the bearing housings, hence the interchangeable term “dry sump.” Here, an oil mist is directed through the rolling element bearings. ISO VG 68 and VG 100 mineral or synthetic oils are used, although ISO VG 32 synthetics would certainly serve the majority of pump bearings and virtually all types of rolling element bearings in electric motors. Decades of experience on thousands of pumps and electric motors attest to the viability and cost effectiveness of modern plant-wide oil mist systems. Typical payback periods on problem pumps have often been less than one year.

#### BEARING TEMPERATURES WITH PREMIUM SYNTHETIC LUBRICANTS

Rigorous experimentation and analysis of pump bearing lubrication using oil mist were conducted at a major university in the 1980s (Bloch and Shamim, 1998). Then, in 2001 and 2002, additional research was performed there (Urbiola Soto, 2002) under the tutelage of Professor Dr. Fred Kettleborough. Although primarily aimed at determining the properties of magnetic bearing housing seals, a series of well-instrumented experiments corroborated and validated other industry-wide observations relating to pump bearings:

- Incorrectly machined oil rings will quickly cause bearing damage.
- A surface finish of 64 rms or better is needed on the oil ring bore.
- Ring eccentricity should not be allowed to exceed 0.002 inch (0.05 mm).
- Operating a 65 mm bearing at 3600 rpm with even a high-quality synthetic lubricant (PAO-base, ISO Grade 32; Urbiola Soto, 2002) reaching the center of the lowest bearing ball caused oil temperatures to exceed 75°C (167°F). Bearing outer ring temperatures hovered around 90°C (194°F).
- Whenever DN values exceed threshold values in the 6000 to 8000 range, it would be best to lower the oil level and employ reasonable means to “lift,” or better yet, spray the oil into the bearing by providing an inductive pump external to the bearing housing to be spray-lubricated (Bloch and Budris, 2004; Bloch, 2001). Oil rings are not the optimum oil application component for many process pumps.

It is worth recalling the earlier observation that a 65 mm bearing operating at 3600 rpm with the oil level set at the center of the lowest ball reached steady-state temperature near 195°F (90°C) after approximately 18 hours (Figure 5). When the oil level was increased until it touched the bottom of the shaft, the operating temperatures increased so rapidly that the test had to be stopped. In only 95 minutes the bearing outer ring had reached 203°F (95°C), while the lube oil temperature was 185°F (85°C) and still exponentially increasing. This was indicated in Figure 6.

#### BEARING TEMPERATURES WITH MINERAL OIL

It should be noted that experimentation outside the literature (Royal Purple Ltd., 2000-2004) and using ISO Grade 68 *mineral* oils, resulted in lube oil temperatures that were 18 to 25°F (10 to 14°C) higher than the temperatures determined in the rigorous testing at the aforementioned university. In essence, *synthetic* ISO Grade 32 viscosity lubricants produce measurably lower frictional energy losses than quality *mineral* oils with the functionally equivalent ISO Grade 68 viscosity. Functional equivalency would be established by the same film thickness and degree of bearing protection achieved by the two different lubricants.

The same can be said for dry sump oil mist lubricated bearings in centrifugal pumps and electric motors. For a variety of reasons, oil mist lubricated bearings will inevitably operate at lower temperatures than conventionally lubricated bearings using the same lubricant at identical loads and speeds (Bloch, 1998; Bloch and Shamim, 1998; Morrison, et al., 1980).

#### SUMMARY AND RECAP OF FINDINGS

Experience shows that some pump manufacturers and pump installation contractors are either unaware of, or disregard, the findings and long-term strategies of truly reliability-focused pump users. To achieve best-of-class pump performance, water-cooling rolling element bearing housings is not only unnecessary, but can also be counterproductive. Similarly, certain traditional lube application methods, and in particular oil rings, have attributes that often disqualify them from use in truly reliability-focused pump user facilities.

Here, then, is a recap of what reliability-focused pump experts know and/or endeavor to implement:

1. Rolling element bearings do *not* require cooling if a lubricant of sufficiently high viscosity is chosen (Bloch, 1998). At startup under cold conditions, a residual amount of oil exists in the contoured “raceway” across the 5-to-7 o’clock segment of the bearing outer ring.
2. Cooling water may still be needed for *sleeve* bearings. Since an “oil wedge” must be established from the moment of startup, suitable lubricant viscosity and lube application characteristics must be ensured at all times. This is achieved by narrowly maintaining oil temperatures, typically using ISO Grade 32 lubricants.
3. Sleeve bearings in pumps must continue to rely on oil rings, unless upgrade measures are implemented by positively spraying oil into the top of the bearing.
4. Synthetic lubricants are ideally suited for high-temperature pump bearings. Premium-grade ISO VG 32 synthetics serve both rolling element and sleeve bearings. Although ISO VG 68 synthetics could be used for rolling element bearings, synthetic VG 32 lubricants will provide adequate lubrication and minimize frictional energy consumed for all except high temperature services.
5. Cooling water *jackets* that surround or are in close proximity to bearing outer rings cool primarily the bearing outer ring, while the bearing inner ring remains at a higher temperature. This causes bearing-internal clearances to vanish and the bearing will experience excessive preload. Close-clearance bearings surrounded by cooling water jackets are almost certain to fail prematurely.

6. Cooling water *coils* in the oil sump tend to promote condensation of the water vapor contained in the air floating above the oil. Lube oil degradation is the inevitable result.

7. Since the early 1970s, thousands of pumps, including those in high temperature service, have been reaching above-average MTBF (mean-time-between-failure) after all cooling water was removed from their respective bearing oil sumps and/or from their respective cooling water jackets.

8. Understand the need to operate certain pumps with lube oil levels set well below the lowermost bearing ball. Never allow lube oil levels to reach the shaft—it only heats up the oil, creates frictional energy, and reduces bearing life.

9. Reliability-focused users acknowledge the vulnerability of oil rings and, for pumps equipped with rolling element bearings, consider flinger discs wherever possible.

10. With few exceptions, rolling element bearings in centrifugal pumps operating in typical process plant environments and moderate ambient temperatures of the United States and Central Europe would be best served by using one of two lubricant grades:

a. ISO Grade 32 synthetic (PAO or dibasic ester or mixed) lubricants for optimized energy efficiency and bearing protection, especially with dry sump oil mist as the application method.

b. ISO Grade 68 mineral oil lubricants for least expensive initial cost and/or where dry sump oil mist is not (yet) recognized as the best life cycle cost strategy.

11. Sleeve bearings in centrifugal pumps operating in typical process plant environments and moderate ambient temperatures of the United States and Central Europe would generally require ISO Grade 32 lubricants.

12. Lube oil contamination is responsible for most bearing distress events. Use clean lubricants and consider hermetically sealing the bearing housing with state-of-the-art housing seals. Alternatively, schedule frequent oil changes. Be aware of the negative bearing life consequences of overlooking these facts.

13. Since the widely used unbalanced constant level lubricators allow the oil level in the surge chamber to be contacted by ambient air with often unsatisfactory cleanliness, use only pressure-balanced constant level lubricators.

14. When installing constant level lubricators on the side of a bearing housing, realize their direction-sensitivity and observe the “up-arrow” orientation requirement.

Always remember that, next to electric motors, pumps are the simplest and most widely used machines on earth. Their complexity is vastly inferior to that of, say, an aircraft jet engine. Yet, in spite of their relative simplicity, many pumps are unreliable. Upgrading process pumps to higher reliability and greater run length is often very straightforward and inexpensive. Payback periods are sometimes measured in months, or even weeks. A “business as usual” attitude is not healthy when competitiveness and jobs are at stake. Both pump users and pump manufacturers can and should take steps to upgrade their process pumps.

#### REFERENCES

- API Standard 610, 2003, “Centrifugal Pumps for Petroleum, Petrochemical and Natural Gas Industry,” Ninth Edition, American Petroleum Institute, Washington, D.C.
- Bloch, H. P., 1998, *Improving Machinery Reliability*, Third Edition, Houston, Texas: Gulf Publishing Company, ISBN 0-88415-661-3.
- Bloch, H. P., 2000, *Practical Lubrication for Industrial Facilities*, Lilburn, Georgia: The Fairmont Press, Inc., ISBN 0-88173-296-6.

- Bloch, H. P., September 2001, “Inductive Pumps Solve Difficult Lubrication Problems,” *Hydrocarbon Processing*.
- Bloch, H. P. and Budris, A., 2004, *Pump User’s Handbook: Life Extension*, Lilburn, Georgia: The Fairmont Press, Inc., ISBN 0-88173-452-7.
- Bloch, H. P. and Shamim, A., 1998, *Oil Mist Lubrication: Practical Applications*, Lilburn, Georgia: The Fairmont Press, Inc., ISBN 0-88173-256-7.
- Bradshaw, S., 2000, “Investigations into the Contamination of Lubricating Oil in Rolling Element Pump Bearing Assemblies,” *Proceedings of the Seventeenth International Pump Users Symposium*, Turbomachinery Laboratory, Texas A&M University, College Station, Texas, pp. 9-16.
- Morrison, F. R., Zielinsky, J., and James, R., 1980, “Effects of Synthetic Fluids on Ball Bearing Performance,” ASME Publication 80-Pet-3.
- Pinkus, O., Decker, O., and Wilcock, D. F., September 1997, “How to Save 5% of Our Energy,” *Mechanical Engineering*.
- Royal Purple Ltd., 2000-2004, Marketing Literature.
- Thibault, R., “Lubrication for Profit,” (training course), rthibault@msn.com.
- Urbiola Soto, L., 2002, “Experimental Investigation on Magnetic Seals,” Master’s Thesis, Texas A&M University, College Station, Texas.
- Villavicencio, E., 2002, “Basic Elements of Tribo-Thermodynamics,” Presented at the First International Symposium on Reliability and Energy Tribo-Efficiency, Mexico City, Mexico.
- Wilcock, D. F. and Booser, R. E., 1957, *Bearing Design and Application*, New York, New York: McGraw-Hill.