

FLOTATION



EMC
eurus mineral consultants

LABORATORY FLOTATION RATE TEST PROCEDURE FOR PGM, BASE METAL SULPHIDE AND OXIDE ORES

FOR A MF1 RATE TEST

LABORATORY FLOTATION RATE TEST PROCEDURE FOR PGM, SULPHIDE AND OXIDE ORES

APPLICATION

This test procedure applies to a single stage MF1 (i.e. primary Mill-Float) rate test. See

DEFINITIONS

A rate test is where a number of concentrates are collected over various time periods in order to generate recovery-time, grade-time and mass-time curves. The data is used to estimate flotation kinetics.

A batch test is when a single concentrate is collected for the full duration of the test.

OBJECTIVE

The purpose of this procedure is to generate information to achieve the following;

- Characterise the ore
- Determine metallurgical variability of samples, ore types and ore mixes from the deposit
- Ascertain what metallurgical changes result in an improvement of recovery/grade such as changes in grind, reagent type and/or addition, pH, pulp density
- Generate data to determine flotation kinetics as a means of optimising flotation plant performance

CHARACTERISTICS OF PGM, SULPHIDE AND OXIDE ORES

Once reagents are added to a PGM and sulphide ore the ore responds to the flotation process for the duration of the test to produce recovery/grade/mass/time relationships. Staged addition of reagents can be tested as an option as opposed to being a necessity. For oxide ores the addition of a sulphidising reagent is a necessity. However, the activity of the sulphidiser tends to be short-lived and after dosing, flotation may only proceed for a relatively short time. Staged addition of sulphidiser and collector may therefore be required at intervals during the batch/rate test. In this case, the air is turned off, reagents added and conditioned, air turned on and the test continued until the next stage addition.

EQUIPMENT

There are a number of standard laboratory flotation machines and cell sizes. The Denver D1 and D12 machines are the most commonly used (Figure 1) and come with a variety of cell and rotor/stator sizes from 1.5 to 8.0 l. (Figure 2). Tests using the 8.0 l cell require a larger rotor/stator. The LabTech Essa machine with 2.5 l cell is shown in Figure 3 and Figure 4 (note that annotations on these pictures are equally applicable to the Denver machine).



Figure 1



Figure 2

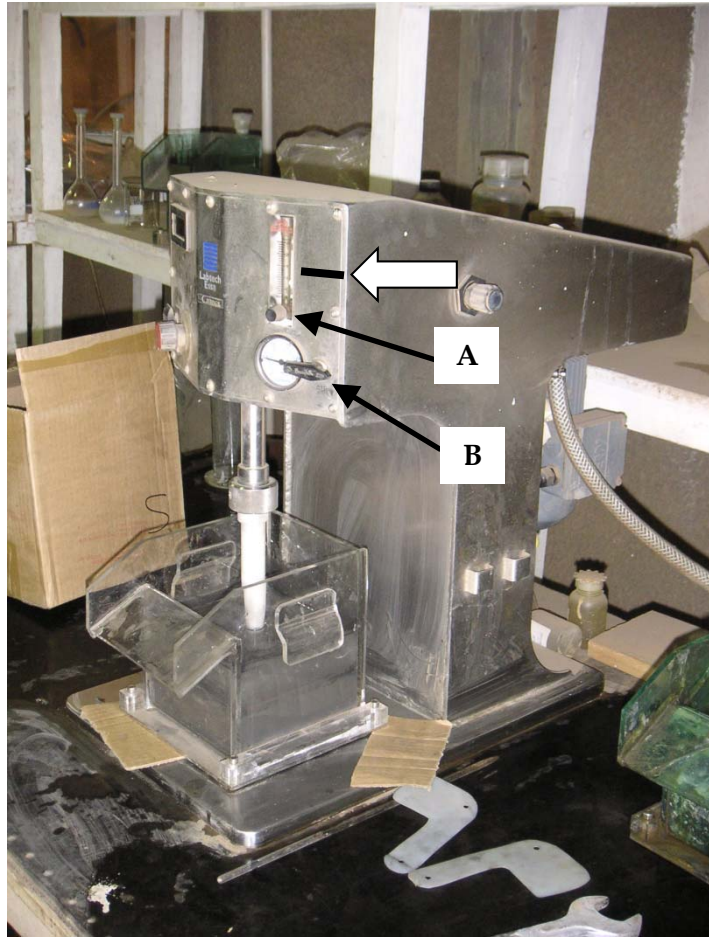

Figure 3



Figure 4

SET-UP

Agitation and Air

Usual set-up conditions for 1.5 to 8.0 l cells are shown in Table 1. Cell air flowrates and cell rpms are plotted in Figure 5. These running conditions are guidelines and are not “cast in stone”. Cell rpm is chosen, usually on a visual basis, to provide adequate agitation and suspension of solids but should not be too intense to cause spillage. The intensity of agitation reduces once air is introduced into the system.

Cell volume and dimensions in Table 1 are detailed in Figure 6. With agitation and airflow, pulp level should be about 10-15mm below the froth overflow lip. As per the illustration in Figure 6, this measurement is approximately the length of a thumbnail (the proverbial “rule of thumb”!). The froth paddles are sized to extend 10mm below the overflow lip. When air is turned on, pulp level rises and it should rise to 10-15mm below the froth overflow lip as represented in Figure 4. The cell should be marked and calibrated for pulp level with agitation and no air so that with airflow, pulp level is 10-15mm below the froth overflow lip. Froth height should be level with the overflow lip.

Guidelines for air addition are given in Table 1. During a test-run an appropriate air set-point was established at about 50% on the rotameter indicated by the line and arrow in Figure 3. Pulp height was about 15mm below the overflow lip (see Figure 4).

Sample Mass

The Denver 2.5 l cell has a live volume of 2.4 l. This is sufficient for 1,0 kg of sample and gives 32% solids in the cell which is a typical float plant feed density. In this case the laboratory mill should be set-up for 1.0 kg of sample as it is practical and best to mill the same mass of sample that will be used in the subsequent flotation test.

The LabTech Essa flotation cell has a live volume of 2.0 l. To float at between 30 and 35% solids Table 2 below shows that 800 gr of solids meets this requirement and allows about 1.25 l of water to be used to wash the solids from mill to float cell.

From a visual analysis using the 2.5 l cell, the Essa flotation machine provided adequate agitation at 1200rpm. This is the maximum that the machine can operate at. Usual rotor speeds for the Denver cell are shown in Table 1.

Measurements for the Denver D12 Laboratory Machine and Cells

	1.5 litre Cell	2.5 litre cell	5.0 litre cell	8.0 litre cell
A mm	115	135	155	195
B mm	115	135	155	195
C mm	165	205	240	295
D mm	120	160	215	260
Nominal Volume (l)) [A*B*D]	1.59	2.92	5.17	9.89
Active Volume to 15mm below overflow lip less 10% for Mechanism (l)) [A*B*(D-15)]	1.25	2.38	4.32	8.38
Usual Airflow (l/min)	6.0	7.5	9.2	11.0
Airflow per Active Volume (min ⁻¹)	4.80	3.15	2.13	1.31
Airflow per Nominal Volume (min ⁻¹)	3.78	2.57	1.78	1.11
Usual Cell rpm	1200	1500	1650	1800

Table 1

FLOAT CELL

Ore SG (t/m ³)	2.7			Choice	Choice		
Lab Cell volume (l)	2.0	2.0	2.0	2.0	2.5	2.5	2.5
% solids	30.0	35.0	38.0	32.0	30.0	35.0	32.0
Pulp RD	1.233	1.283	1.315	1.252	1.233	1.283	1.252
Pulp (kg)	2.47	2.57	2.63	2.50	3.08	3.21	3.13
Solids (kg)	0.740	0.898	1.000	0.800	0.925	1.122	1.000
Water (l)	1.73	1.67	1.63	1.70	2.16	2.08	2.13

MILL

Mill % Solids	65.0			Choice	Choice		
Pulp RD	1.693			Choice	Choice		
Pulp (kg)	1.138	1.381	1.538	1.231	1.423	1.727	1.538
Solids (kg)	0.740	0.898	1.000	0.800	0.925	1.122	1.000
Water (l)	0.40	0.48	0.54	0.43	0.50	0.60	0.54

WATER AVAILABLE TO WASH FROM MILL INTO CELL

Water (l)	1.33	1.18	1.09	1.27	1.66	1.48	1.59
-----------	------	------	------	------	------	------	------

Table 2

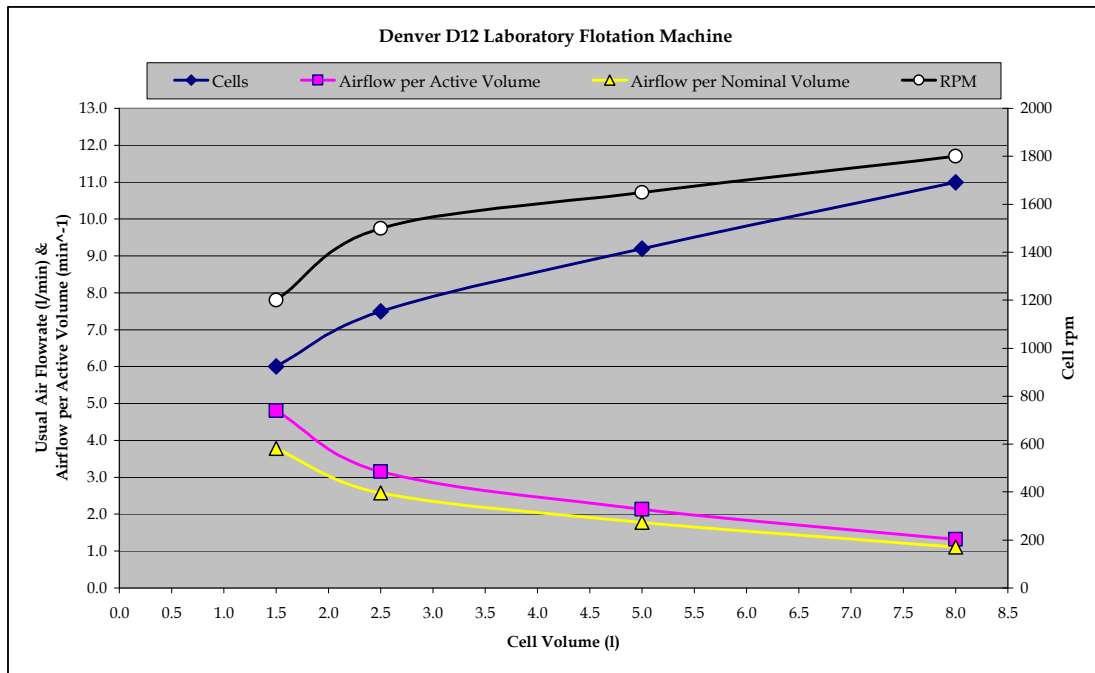

Figure 5

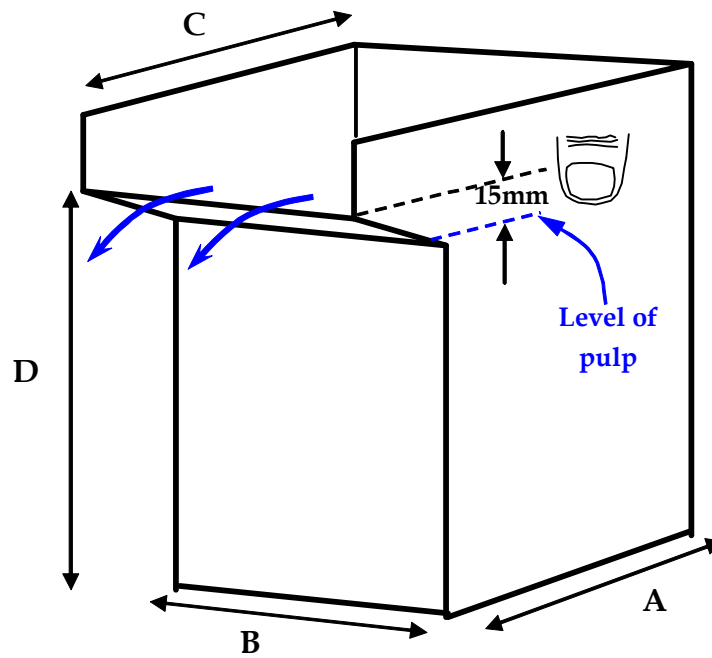

Figure 6

Froth Paddles

Froth paddles should be sized and shaped as per the illustration in **Figure 7**. The paddles should be half the width of the cell, extend 10mm below the froth overflow lip and have handles. When collecting froth the paddle should sit on the cell wall so that froth collection depth is constant. The paddle can then slide along the cell wall from back to front ie “A” to “B” in Figure 11.

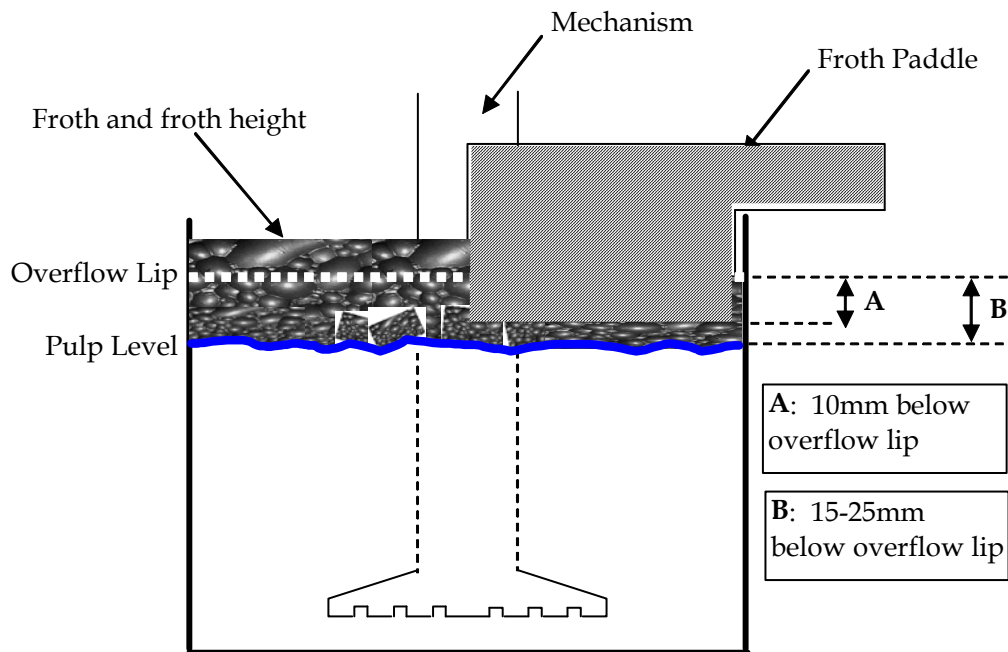

Figure 7

Determining Froth Collection Times

There are four important issues for both assayed elements and the mass/gangue component. The number and timing of concentrates collection should be arranged so that;

1. The shape of the recovery-time curve can be accurately described mathematically
2. The fast floating fraction collected at the start of the test is adequately represented and measured (see **Figure 9**)
3. The slow floating fraction collected towards the end of the test is adequately represented and measured (see **Figure 9**)
4. Sufficient sample is generated so that all analytes can be assayed. If this is not possible then duplicate/triplicate tests should be done.

In points 3 and 4 above, flotation concentrates should be timed so that the shape and position of the fast and slow floating sections of the curve can be well delineated and the slow floating section should be approaching or have approached a plateau, ie the recovery-time curve should have two distinct components with a discernable inflection point as per the bottom curve in Figure 9. If the recovery-time curve trend is described by a straight line as shown by the mass curve (red line, triangle markers) in Figure 10 then the test should be redone for a longer time to generate a curve with two distinct fast and slow sections. An example of this is shown in Figure 10 where the original test had to be redone for an extended flotation time from 23 to 40 minutes.

From a cost and sample processing point of view the minimum number of concentrates to adequately describe the recovery-time curve and the ore's flotation characteristic is four timed at 1, 3, 10 and 20 minutes. The first concentrate has the smallest mass and if this is a problem for assay, then the first two concentrate collection times can be moved to 2 and 4 minutes without adversely affecting the accuracy of estimating fast floating kinetics.

The table below recommends concentrate collection times for three categories of ore according to how fast mineral and gangue float and how quickly the recovery-time curve forms a plateau. The choice of collection times should suit the slowest floating component which is usually mass. For example, a 20 minute float would suit the ores in Figure 9 and the top curve in Figure 10, but only a 40 minute float would be suitable for an ore with a mass-time curve in Figure 8 and the bottom curve of Figure 10.

A		B		C	
Average to Fast Floating Ores		Average to Slow Floating Ores		Slow Floating Ores and/or linear mass-time ores	
Time (min)	Conc	Time (min)	Conc	Time (min)	Conc
1	1	1	1	2	1
3	2	3	2	5	2
7	3	15	3	20	3
20	4	30	4	40	4

Alternately:		Alternately:	
Time (min)	Conc	Time (min)	Conc
1	1	2	1
3	2	5	2
7	3	10	3
20	4	25	4
30	5	40	5

The following excerpt from “Using Simulation to Understand Metal and Mineral Flotation Performance at one of Falconbridge’s Base Metal Operations”; M. P. Hay et al, Nickel 05 Conference, Cape Town serves to outline the importance of not generating a linear recovery-time curve.

Determination of Flotation Kinetics

Fitting Kelsall’s parameters to a normal recovery and grade profile such as for Copper was achieved with a high level of accuracy. In contrast, the cumulative mass-time profile in Figure 8 posed quite a problem because it was essentially linear with a correlation coefficient, r^2 , of 0.976. It is not possible to fit a two component equation to a linear or near-linear relationship. In cases such as this a solution is often generated where both fast and slow floating rates have equal values. This is mathematically correct but does not occur in practice. When both rates are equal the fast floating fraction can be assigned any value between 0.0 and 1.0 without making any difference to the resulting mass recovery-time profile and these kinetic data are useless for simulation. For example the two laboratory test profiles in Figure 8 can be described by the two-component Kelsall equation;

$$\text{Cumulative mass recovery} = (100 - \theta) [1 - \exp(-kGF*t)] + \theta[1 - \exp(-kGS*t)]$$

where $kGF=kGS=0.0160$ with θ being any value – as described by the dashed line.

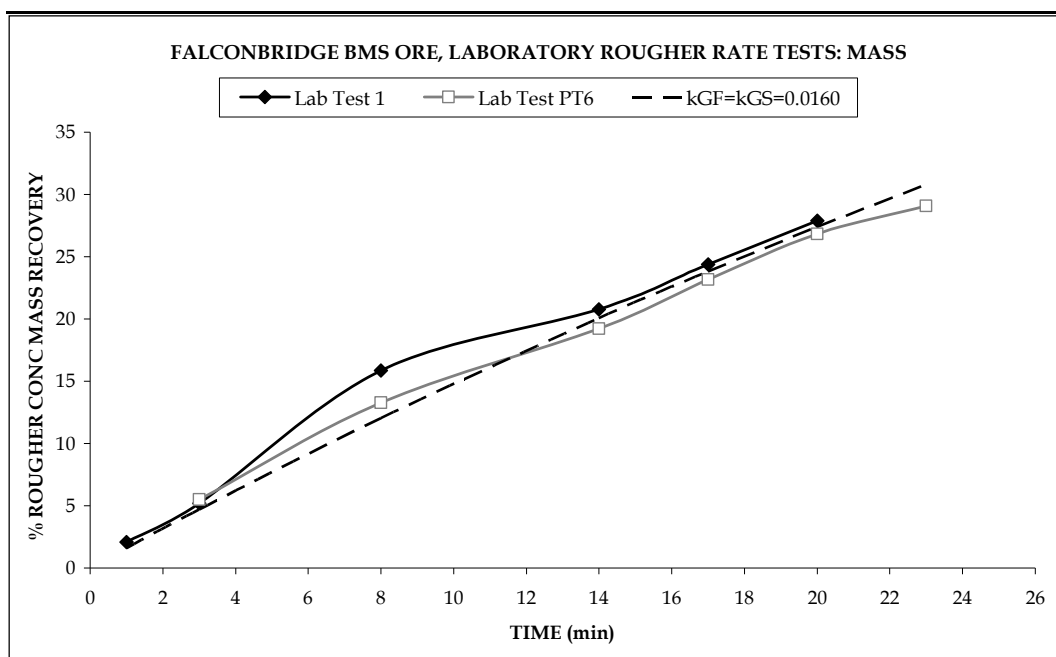

Figure 8 Laboratory Test Data: Mass

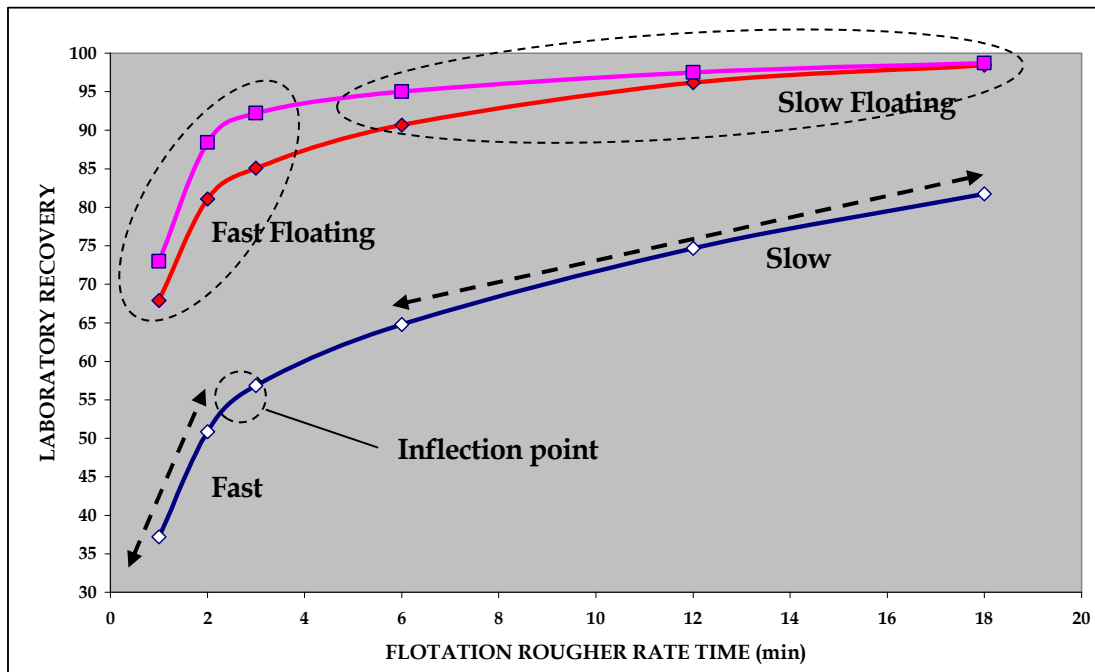

Figure 9

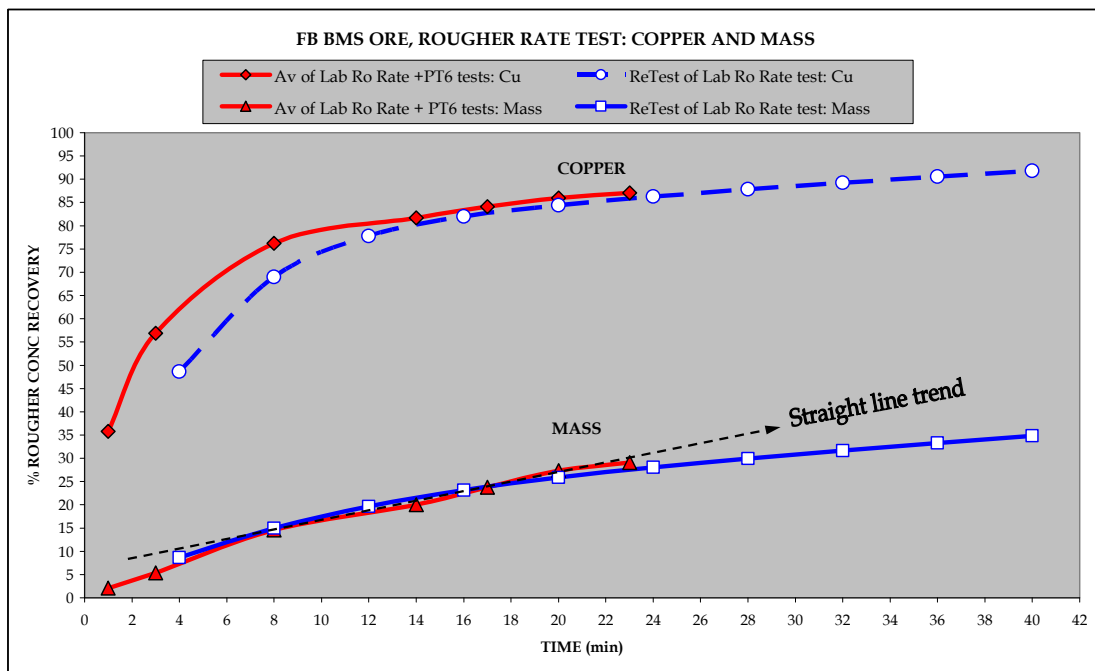

Figure 10

DETAILS OF LABORATORY FLOTATION PROCEDURE

Sample

There are two types of test designated by sample source;

1. Sample that has been milled in a laboratory mill, referred to as a “lab” test or “lab” float and
2. Sample that has been taken from a flotation circuit, either pilot or plant scale, referred to as a “hot” float.

Mixing and Reagent Addition

- Air should be off
- Set cell rpm
- Pulp level should be to the calibration mark
- If pH must be modified or reagents added, do so in the desired order and addition rate.

Air Rate

LabTech Essa

The test is begun by opening the air. The aim throughout the test is to maintain the top of the froth bed level with the overflow lip of the cell. The set point for air flow has been marked at about 50% on the rotameter (indicated by the dark line and white arrow in Figure 3). This setting is suitable for a 2.0/2.5 l cell. If a smaller or larger cell is used then air rate will need to be adjusted as per Table 1. Air flow should not be increased greater than the set point because an unstable situation can be created where air begins to blast through the froth.

Air rate is adjusted by the knob marked “A” and flow is turned on/off by the switch marked “B”. The ideal is to have previously set knob “A” and on starting the test, switch “B” is then turned to “on” so that the test begins with the set point flow of air. This may not always be possible depending on the floatability of the ore. If this is high, concentrate production will be voluminous and a runaway froth will occur which will be uncontrollable (ie concentrate overflow without having to use the paddles). For very floatable ores it is best to begin the test by slowly opening the air and gradually building a

froth bed until it becomes level with the overflow lip. As soon as this is done timed concentrate collection can begin.

What is required is that the froth is controlled at all times and is kept level with the overflow lip of the cell. Thus at the start of the test, air valve “A” will need to be adjusted and then gradually opened to the set point. After this, the level of pulp is topped up with water to maintain froth level. All the time, froth is collected by paddle and the quantity of froth removed is always controlled by the paddle design and the frequency of collection.

Denver

If the Denver machine is fitted with an air supply and rotameter then the above description for the LabTech Essa machine applies. If this is not fitted, air is controlled by the small “tap” shaped valve at the top of the stainless steel shaft. The same control is required via this valve for very floatable and voluminous froths.

Froth Collection

Froth is collected every 15 seconds and consists of two sweeps of the paddles one immediately after the other from the back of the cell to the front (“A” to “B”, Figure 11). As the paddles moved forward they are angled around the mechanism and brought back together again before moving to the front of the cell (Figure 12). At all times the paddles must be operated in unison as a pair so that froth is removed in a uniform manner across the full width of the cell.

- There are four collections of concentrate in every minute,
- Collection begins on the minute and is repeated every 15 seconds,
- Collection finishes at the 45 second mark.

An example of a 4 and 7 concentrate collection test is shown in Table 3. The timing and sequence of collections is illustrated in Table 4. Note that the test, test conditions and pulp level are set-up followed by air rate so that froth is level with the overflow lip. As soon as this is done the test begins and froth collection can begin immediately (ie at 5 seconds), followed by a second collection at 15 seconds. Thereafter collection is at every 15 second interval.

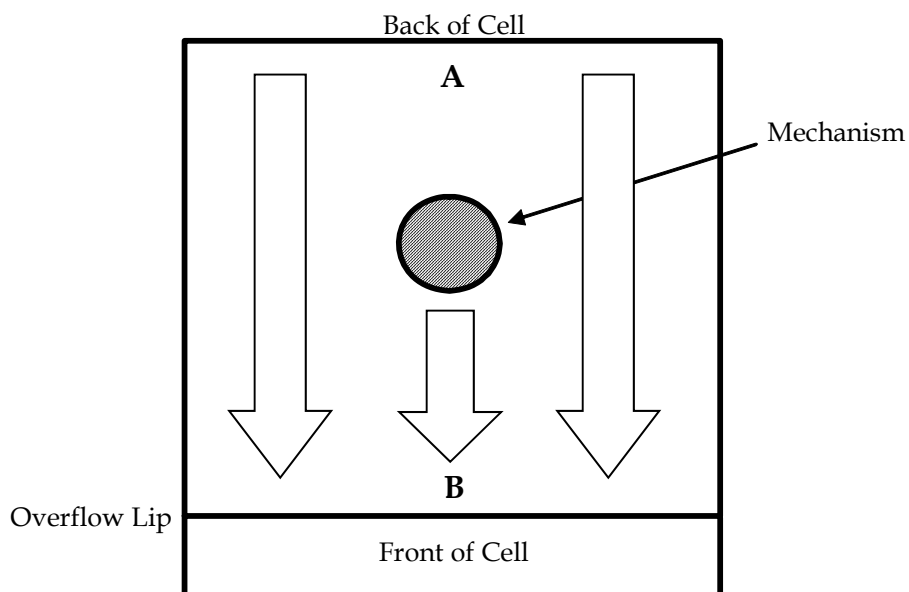

Figure 11

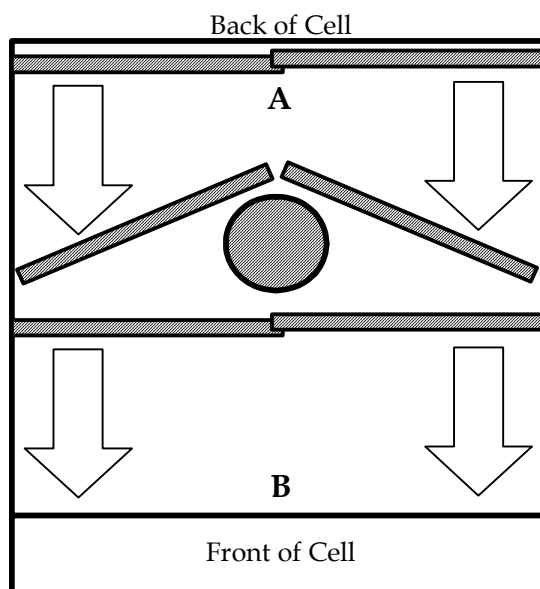

Figure 12

If 4 Concentrates are Collected

Concentrate	Collected between....		
1	0 min	and	45 sec
2	1 min	and	2m 45s
3	3 min	and	9m 45s
4	10 min	and	30 min

Similarly with 7 Concentrates

Concentrate	Collected between....		
1	0 min	and	45 sec
2	1 min	and	1m 45s
3	2 min	and	2m 45s
4	3 min	and	5m 45s
5	6 min	and	11m 45s
6	12 min	and	19m 45s
7	20 min	and	30 min

Table 3

Min	Secs		
		Before timing, set-up test, air rate and froth level	
0	0	Begin test	
0	5	Two sweep froth collection	} Conc 1
0	15	Two sweep froth collection	
0	30	Two sweep froth collection	
0	45	Two sweep froth collection	
1	00	Two sweep froth collection	} Conc 2
1	15	Two sweep froth collection	
1	30	Two sweep froth collection	
1	45	Two sweep froth collection	
2	00	Two sweep froth collection	} Conc 3
2	15	Two sweep froth collection	
2	30	Two sweep froth collection	
2	45	Two sweep froth collection	
3	00	Two sweep froth collection	
3	15	Two sweep froth collection	
3	30	Two sweep froth collection	
etc to end of test			

Table 4

Washing Down and Water Addition

After the second sweep of each collection any material adhering to the paddles should be washed off into the concentrate collection dish. Occasionally, wash down adhered material around the sides of the cell and mechanism.

When air rate is at the set point and froth level begins to fall below the level of the overflow lip, pulp level should be topped with water.

Thin Froth towards the end of a Test

One of the main requirements of a flotation test is to maintain a decent froth structure and level. If the froth becomes very thin, turn the air off, put the stopwatch on pause, add one drop of frother, condition for 1 minute and then restart the test, stopwatch and froth collection.

Treatment of Products

All concentrate and tailings are weighed (dish+pulp), then filtered, dried, dry weight recorded and sent for assay. This records dry mass and contained water for each product. If the sample contains sulphur/sulphides drying must be done in a low temperature oven (40°C) to avoid burning off any sulphur/sulphides.

Immediately after the Test

Remove the mechanism from the pulp and record the volume of pulp remaining in the cell. Thoroughly wash down the outside and inside of the mechanism into the cell.

Particle Size Analysis

Apart from a means of concentrating economic elements and metals, the flotation process is also a size classifier. Fines are preferentially recovered into the concentrate from the feed stream with an upper d90 size limit of approximately 125-150µm depending on the floatability of the ore type being treated. For example feed at 40% -75µm produces concentrate at about 60-70% -75µm and feed at 70-80% -75µm produces concentrate at about 90-95% -75µm. The particle size distribution across a flotation bank or circuit can be duplicated by using a hydrocyclone model where flotation concentrate is represented by cyclone overflow and flotation tailings by cyclone underflow.

A few batch tests should be done to determine this particle size relationship for the various ore types and ore mixes. This is essential data when checking the grind of the laboratory mill. After a test, a representative sample of final tailings can be sent for assay and a further representative sample subjected to screening (the balance of the tailings material can be stored in case a re-assay is necessary). The particle size distribution and % -75 μ m of float feed is then determined by combining the mass and grading of tailings and concentrate streams.

REAGENT ADDITION

Reagents should be fresh and made-up on the day. Large additions of dilute reagent such as depressant should be added by pipette or a large barrel syringe.

In cases where it is necessary to add a reagent neat – such as a frother – the required addition can be just one drop. Small additions of reagent need to be added using a small barrel medical syringe with a thin hypodermic needle. One drop has a volume of 0.02cm³. In a test using 1kg in a 2.5l cell this is equivalent to 20g/t which is a sizeable dose in a plant.

CALIBRATION, ORGANISATION AND PRACTICE

It is essential to calibrate the flotation cell and machine, practice test technique and develop a system;

- Sufficient pipettes and/or syringe/needles should be available
- A supply of water (tap or plant) should be readily available at arms length
- A number of wash bottles which can be easily refilled in between concentrate collection sweeps without having to move away from the cell and without missing a concentrate collection period
- Concentrate dishes should be large enough to contain what can be a large pulp volume, especially for the last concentrate. The containers should be labelled before the test begins
- Practice *within 15 seconds*:
 - Conducting two concentrate collection sweeps,
 - The dexterity of holding both paddles in one hand and washing them both into the concentrate container with a wash bottle in the other hand,

- Washing material on the sides of the cell and mechanism back into the cell and
- Checking and topping up pulp level.

TEST TECHNIQUE

The set-up and execution of a rate test needs to be more organised. Remember what I said when we did some practice tests during my visit on 24th-27th October. Conducting a rate test is an intensive activity where the operator is continuously on the go for the duration of the test. In a period of 15 seconds the operator needs to do some or all of,

- a. Two collections of froth from back to front of the cell,
- b. Wash down the paddles into the concentrate dish,
- c. If needs be wash down froth adhered to the insides of the cell and around the shaft,
- d. Check pulp level,
- e. Top up pulp level with water,
- f. Add reagents if stage adding say collector,
- g. If needs be add extra frother,
- h. Change concentrate dishes and
- i. Check the time.

To do all this four times a minute for a 30 minute test requires much practice in order for the test to run smoothly. The intensity of the test requires everything to be at hand with the items logically arranged around the cell.

For example once the test has started there is no time to fill up a wash bottle so there must be 4 full ones at the start of the test. Label the concentrate collection dishes beforehand, as it is easy to forget which is which if they are moved around after the test. Practice adding one drop of reagent from a syringe. This is not easy to do within the time schedule of a-i above. It is easy to press the plunger too hard and a stream of reagent gets added at which point the test is ruined. Thus, if the froth is thin and it is necessary to add more frother, one (maximum two) drop(s) will suffice. Getting this wrong and adding a stream of frother might add (say) 120g/t in which case the froth will be voluminous, mass pull will be unrealistically high and the test must be abandoned.

A supply of syringes and small needles is important. Each should be labelled and used for a certain reagent. Each should be thorough washed at the end of the day and kept overnight in a beaker of water.

Suggested Lay-out of the Bench for a Rate Test

Figure 13 shows a suggested arrangement of equipment around the float cell so that everything that is needed is easily at hand. The flow of work – i.e. the movement of concentrate collection dishes 1-4 – is assumed to be right to left. Adequate space should be available on both sides of the float cell so that the dishes can be moved rapidly right to left during the test.

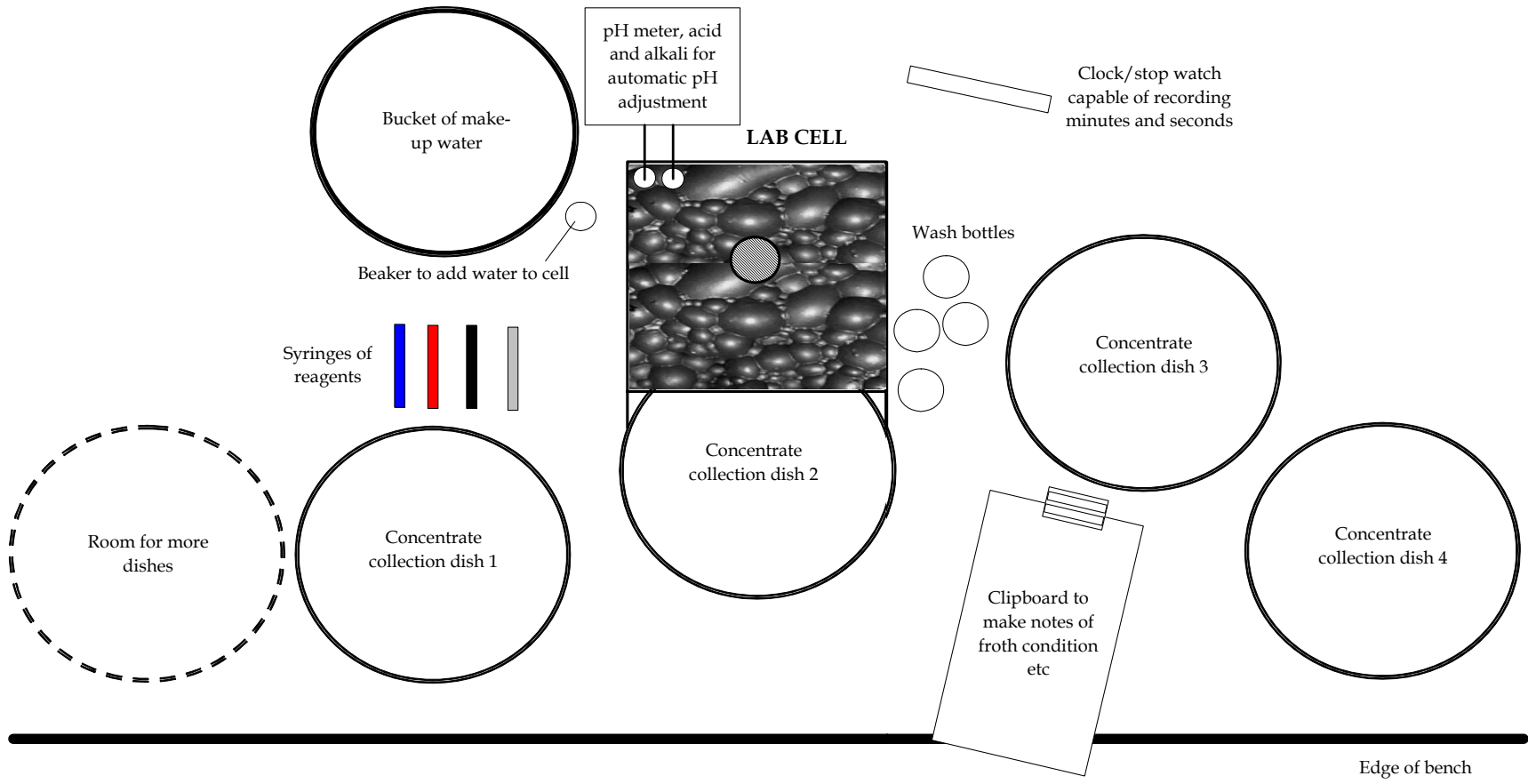

Figure 13