

DESIGN CONSIDERATIONS FOR NONCLOG PUMPS

by

Richard J. Cronin

Senior Staff Engineer

Mechanical Solutions Incorporated

Eldersburg, Maryland

David A. House

Principal Engineer

and

Alan C. Miller

Senior Upgrades Engineer

Flowserve Corporation, Pump Division

Taneytown, Maryland



Richard J. Cronin is a Senior Engineer for Mechanical Solutions, Inc., in Eldersburg, Maryland. He has more than 15 years of experience in the design, development, analysis, and troubleshooting of rotating equipment. While at Ingersoll-Dresser Pump (Flowserve), he was the lead mechanical design engineer for the development of their line of submersible sewage pumps (MSX) and vertical turbine nonclog pumps (QMN). He received three

United States and international patents for work performed on these developments.

Mr. Cronin has a BSME degree from the University of Maryland at College Park, and he is a registered Professional Engineer in the States of Virginia and Maryland.



David A. House is a Principal Engineer for Flowserve Pump Division, in Taneytown, Maryland. He has more than 30 years of experience in the application, design, development, analysis, and troubleshooting of nonclog and water pumping equipment. He has been the principal mechanical design engineer for product enhancements to the Flowserve line of dry pit nonclog pumps, and he has overseen the development of many new sizes of dry pit

nonclog pumps (MF and MN) and new sizes of vertical turbine nonclog pumps (QMN) over the past 20 years.

Mr. House has a BSME degree from the University of Maryland at College Park.



Alan C. Miller is the Senior Upgrades Engineer for the Flowserve Pump Division, in Taneytown, Maryland. He has more than 34 years of experience dealing with turbomachinery, especially pumps. His experience includes: test engineering, product engineering and design, quality assurance, and engineering management. Currently he develops and applies upgrades to customers' existing pumps,

providing savings in capital and maintenance expense while increasing pump life.

Mr. Miller has a BSME from the Pennsylvania State University at State College.

ABSTRACT

Nonclog pumps, as defined by the Hydraulic Institute (ANSI/HI Standard 1.3, 2000), are "pumps designed to assure maximum freedom from clogging when handling liquids containing solids or stringy material." These pumps are also commonly known as solids handling or sewage pumps. The category of nonclog pumps encompasses a broad range of pump sizes and designs representing one of the largest market segments available. This paper focuses on centrifugal nonclog pumps 3 bhp and greater with a discharge diameter larger than 3 inch. The available types, operation, design elements, materials, driver configuration, and variable speed operation are presented herein. Typical field problems with their resolution, vibration analysis, and equipment upgrades are also discussed.

INTRODUCTION

Design

The typical nonclog pump is a single volute with the casing and impeller designed with wide passages to pass solids. The impeller is overhung on the shaft and the rotating assembly is back pull-out so it may be removed without disturbing the pump casing or suction head. Nonclog pump designs are available in specific speeds $N_s = 1500$ to 5000 with most designs in the range of $N_s = 2000$ to 3500 . Flows are available from 100 to $100,000+$ gpm with heads from 10 ft to 250 ft TDH.

Applications

A nonclog pump is used when the liquid being pumped has the ability to adversely affect a pump's performance through the accumulation of problem materials in choke points such as the impeller eye and wear rings. The liquid pumped is typically raw or in-process sewage but nonclog pumps can also be found in mine dewatering, construction, industrial processes with solids in suspension, raw water intake, and cooling water.

Solid Size

A nonclog pump specification should designate the maximum diameter of the solid expected to pass through the pump without clogging. The minimum solid size diameter accepted as standard by

many US states is 3 inch. By consequence, the minimum nonclog pump size is 3 inch discharge to allow passage of the 3 inch diameter solid into and out of the pump. The maximum nonclog pump size is limited only by the requirements of the end users who base their pump sizes on commercially available pipe used in the construction of wastewater processing plants. This effectively limits the available pumps size to 60 inch discharge diameter. A 60 inch discharge diameter pump specification is rare and more commonly seen pump sizes range from 3 inch to 48 inch discharge diameter.

Stringy Material

In addition to passing a minimum diameter solid, a nonclog pump is expected to pass stringy material, rags, other problem solids such as hair and grease conglomerates, and a minimum of 2 percent solids in suspension. That is not to say that nonclog pumps will not clog if faced with difficult solids they were not designed to pass. Should a nonclog pump designed to pass a 3 inch diameter solid be expected to pass a 12 inch long by 3 inch wide rag simply because it has little thickness? Of course not since the rag will likely wrap around the impeller suction vanes tips. The Hydraulic Institute (ANSI/HI Standard 1.3, 2000) recognizes such problems and recommends comminution and/or adequate bar screens be provided upstream of the pumps when necessary.

APPLICATIONS

Wastewater Collection

Nonclog pumps used for domestic wastewater can be classified into pre and postwastewater treatment. The pretreatment pumps are used to collect raw wastewater and transfer it to the wastewater treatment plant. The first collection station and stations thereafter are located at the point of lowest hydraulic grade. Raw wastewater gravity feeds from its source to the collection station where its total dynamic head (TDH) is raised to allow flow to the next collection station. The next station downstream may have a number of smaller stations feeding it and so its size is larger than the first. The size of the collection stations continually increases until the raw wastewater reaches the wastewater treatment plant.

Wastewater Treatment

In the wastewater treatment plant nonclog pumps are used to transfer wastewater through the various stages in the treatment process such as primary, secondary, and tertiary treatment. Most of the large solids are removed in the primary treatment and it is here that nonclog pumps see the most use. Nonclog pumps in the secondary process are used as sludge pumps to transfer solids in suspension between tanks. At the end of the treatment process, the treated water is pumped back to the environment using effluent pumps that many times are a nonclog design.

Collection Station Configuration

There are two methods in wide use in the design of wastewater collection stations. In both design methods wastewater flows into a collection chamber called the wet-well. The wet-well is a pit dug into the earth and is located at the point of lowest hydraulic grade.

Wet-Well Only

The first design method (Figure 1) places the pump within the wet-well and this necessitates the pump being able to operate in a submerged condition.

Wet-Well/Dry-Well

In the second design method (Figure 2) the size of the pit dug for the wet-well is approximately doubled and a vertical wall is placed in the center of the pit to divide it in two. The first half of the pit is used as a wet-well and the second half is used as a dry-well to house the pumping equipment. Pumps used in the wet-well/dry-well configuration can be conventional dry-pit pumps. The cost of

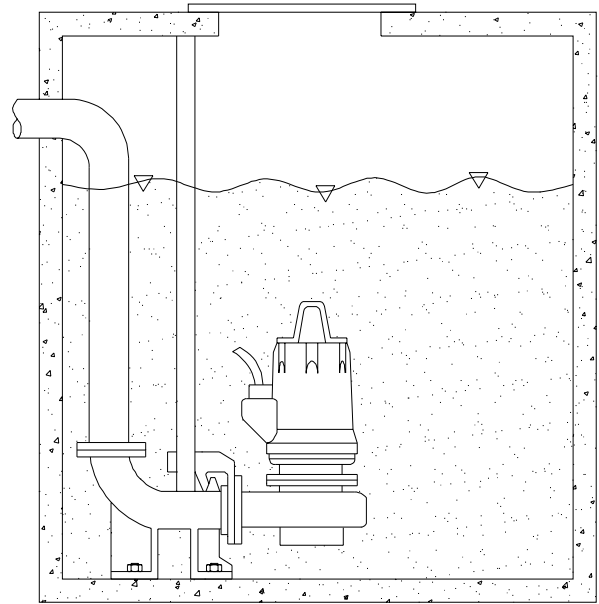

Figure 1. Wet-Well Only.

construction for the wet-well/dry-well configuration is higher than the wet-well only approach due to the additional material excavated, additional concrete poured, and additional equipment required such as lighting and heating, ventilation, and air conditioning (HVAC).

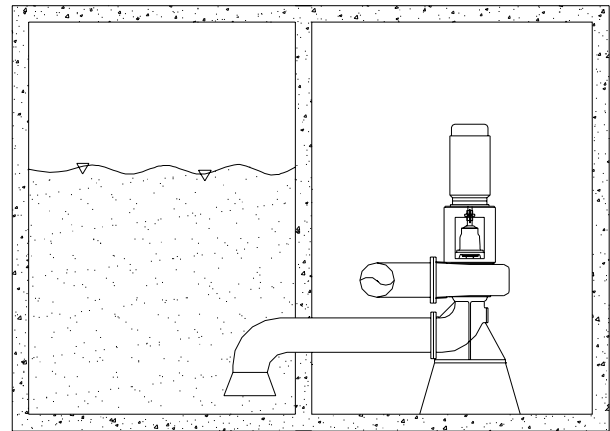

Figure 2. Wet-Well/Dry-Well.

PUMP TYPES

Submersible Pump/Motor

Submersible pump/motor combinations (Figure 3) are available in flows from 100 to 50,000 gpm with heads ranging from 10 ft to 250 ft TDH. In this design the pump is close-coupled to the motor. The impeller is mounted on the motor shaft and the motor bearings carry all radial and thrust loading imposed by the pump. The motor may be of oil filled or air filled design with oil filled designed regimented to the smaller motor sizes to keep efficiency losses at a minimum.

Motor Chamber Design

The motor chamber is sealed from the pump liquid using at least one mechanical seal and in most cases two seals are provided. The two seal method allows the space between the motor housing and the pump casing to be filled with oil and a moisture sensing probe is placed within the chamber. If the primary seal fails, the chamber

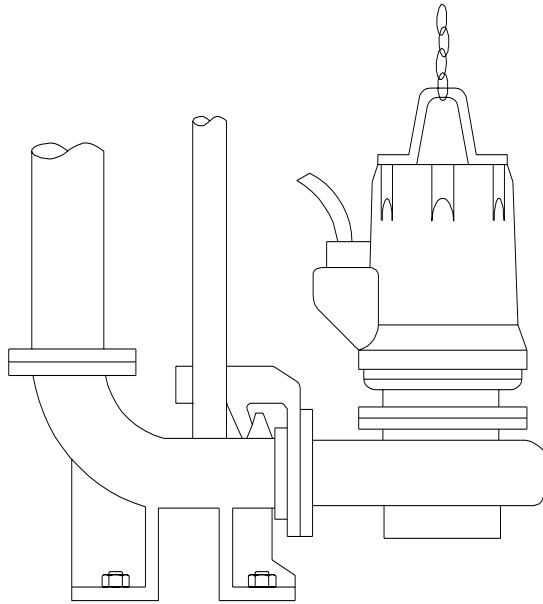

Figure 3. Wet-Well Submersible.

begins to fill with water and the moisture sensor alerts the station operator of a primary seal failure. The secondary seal acts to prevent the admission of oil and water into the motor housing in the event of primary seal failure.

Power Cables

Power is supplied to the motor using cables listed to NFPA 70 (National Electric Code) Section 400. The cables are designated for extra hard usage, employ thermoset plastic insulation and oil-resistant thermoset jackets, and are suitable for submersion in water.

Motor Cooling

The motor is cooled through convection from the motor shell to the fluid in the wet-well. Additional cooling may be supplied by transferring heat from the motor to the pumped fluid using a circulated cooling system that can be supplied as either a closed loop or open loop system. In the closed loop system a clean fluid is circulated around the motor and the heat is transferred to the pumped fluid using a heat exchanger integral with the motor. The open loop system bleeds off a portion of the pumped fluid, circulates it around the motor, and then returns it to the pump. Over time the open loop system may accumulate grit, grime, grease, sewage, etc., on the shell of the motor housing. This accumulation reduces the ability of the motor to transfer heat and results in increased motor operating temperatures.

Wet-Well Use

Submersible pump/motors installed in a wet-well are typically mounted on rails and lowered into the wet-well and accessed for maintenance via the rails. Large pump/motors can be difficult to handle in and out of the wet-well due to their size, weight, and rigging requirements. Bosserman and Behnke (1998) have suggested that brake horsepower (bhp) for wet-well submersible pumps be limited to 150 bhp to keep the size of the units reasonable for handling. If the wet-well is rated as a hazardous location then the motor must be certified for use in that environment.

Dry-Well Use

Submersible pump/motors can be installed in a dry-pit (Figure 4) instead of, or as a replacement for, a conventional vertical

frame-mounted pump. A circulating cooling system must be used or the motor must be derated since many pump/motor combinations rated for use in wet-wells cannot be used in a dry-well or continually operated in a wet-well with the fluid level below the motor housing without overheating the motor. If the pumped fluid is circulated around the motor, then ensure that the jacket is periodically cleaned or the motor is derated to account for the accumulation of particulates/sludge on the jacket and the corresponding reduction in heat transfer.



Figure 4. Dry-Well Submersible.

Vertical Turbine Nonclog Pumps

Vertical turbine nonclog pumps (Figure 5) are available in flows from 1500 to 70,000 gpm with heads ranging from 10 ft to 100 ft TDH/stage. Vertical turbine nonclog pumps combine the proven technologies of vertical turbine type pumps with that of a nonclog pump design. Most of the pump uses standard vertical turbine pump (VTP) technology such as column pipe, shafting, bearings, and discharge head. It differs from standard VTP pumps by using an overhung impeller with no bearing in the suction bell (tail bearing), a nonclog impeller, a nonclog diffuser (bowl) with two or three vanes, and a splitter in the column and discharge elbow to prevent the accumulation of material at the intersection of the enclosing tube with the discharge head elbow. The line shaft and bowl bearing are flushed with clean water from an external source. The pump is operated submerged in the wet-well and the motor is mounted above the wet-well and is therefore protected from flooding by the pumped fluid. The motor carries the hydraulic thrust of the pump and the motor thrust bearing must be sized accordingly. The entire pump must be pulled for maintenance.

Dry Pit

Conventional dry-pit nonclog pumps are available in flows from 100 to 100,000+ gpm with heads ranging from 10 ft to 250 ft TDH. The available design variants are horizontally-mounted, vertical frame-mounted, and vertical long-shafted.

Horizontally-Mounted

A horizontally-mounted nonclog pump (Figure 6) places the pump and driver on a common baseplate in the dry-pit. This configuration exposes both the pump and motor to flooding, places all equipment together for ease of maintenance, requires no vertical floor penetrations, and minimizes height requirements. However,

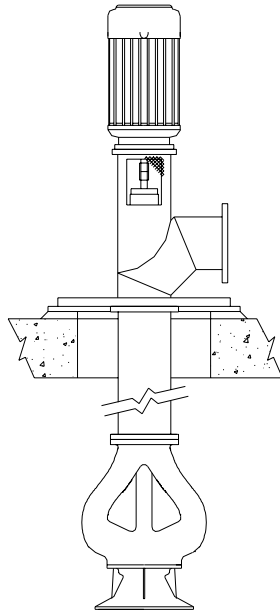

Figure 5. Vertical Turbine Nonclog Pump.

what would have gone up must now be laid on its side and horizontally-mounted units take up more square footage of floor space than their vertical frame-mounted cousins. The coupling placed between the driver and the pump can be a gear, flexible-disc, elastomeric, or spring-grid design. The use of a spacer coupling between the driver and pump allows the removal and maintenance of the pump pull-out assembly without disturbing the driver. The pump normally carries all hydraulic loading and vibration is minimal due to rigid mounting.



Figure 6. Horizontal Nonclog Pump.

Vertical Frame-Mounted

A vertical frame-mounted nonclog pump is mounted vertically in the dry-well with the motor mounted directly to it using a motor stand. This configuration exposes both the pump and motor to flooding and places all equipment together for ease of maintenance. It requires less floor space than horizontally-mounted equipment but requires more vertical rise. The coupling placed between the driver and the pump can be a gear, flexible-disc, elastomeric, or spring-grid design. The pump normally carries all hydraulic loading.

Reed-Critical Frequency—The rise in vertical height makes the vertical frame-mounted pump susceptible to higher vibration levels

since the point of rotation for the unit center of gravity is about the base and allows a small force to create a larger moment. Vibration levels on a vertical frame-mounted unit will be higher than those of identical units that are either horizontally-mounted or are vertical long-shafted. In addition, the direct mounting of the motor above the pump adds to system flexibility and the reed-critical frequency of the assembled motor/pump/foundation system can be considerably below that calculated for the pump or the motor alone. It is not uncommon for the assembled reed-critical frequency to be on the order of 50 percent of that calculated for the motor alone.

Motor Stand Mounting—Mounting of the motor stand to the pump is accomplished by either mounting to the casing pressure flange or to feet cast integral with the casing.

On pumps 24 inch discharge diameter and less the motor stand is usually mounted to the casing pressure flange (Figure 7). The overall stiffness of this mounting is low due to flexibility of the casing wall and casing flexing due to pressure pulsations can increase the motor vibration levels. The addition of the motor stand can limit available space to work on couplings and seals.



Figure 7. Vertical Frame Mounted (Casing Pressure Flange) Nonclog Pump.

On pumps 30 inch discharge diameter and larger the motor stand will normally be mounted on feet cast integral with the casing (Figure 8). The feet should be located near the outer periphery of the pump casing so that the motor load is transferred directly to the foundation where possible. This will provide high stiffness, rigid mounting, and good vibration levels. Mounting the motor stand on feet cast integral with the casing also minimizes vibration increase as a result of pressure fluctuations within the casing and potentially provides more room to work on the coupling and seal. These advantages result in increased cost for both the casing casting and the motor stand weldment.

Vertical Long-Shafted

In a vertical long-shafted unit (Figure 9) the pump is mounted vertically in the dry-well and the motor is mounted on a floor(s) above. This configuration exposes the pump to flooding but protects the motor, which is easily damaged and expensive to repair. The pump and driver are connected using intermediate driveshaft(s) of universal-joint, flexible-disc, or solid shafting design. The combined length of the intermediate driveshaft(s) is not limited but the length of the individual sections is limited by



Figure 8. Vertical Frame Mounted (Feet Cast Integral with the Casing) Nonclog Pump.

their individual lateral natural frequency. It is not unusual to have more than one intermediate driveshaft with two or three driveshaft sections being the norm. Adding more than one section of shafting comes at the cost of adding steady bearings to support the intermediate driveshaft sections and the maintenance that goes along with them. The pump normally carries all hydraulic loading.

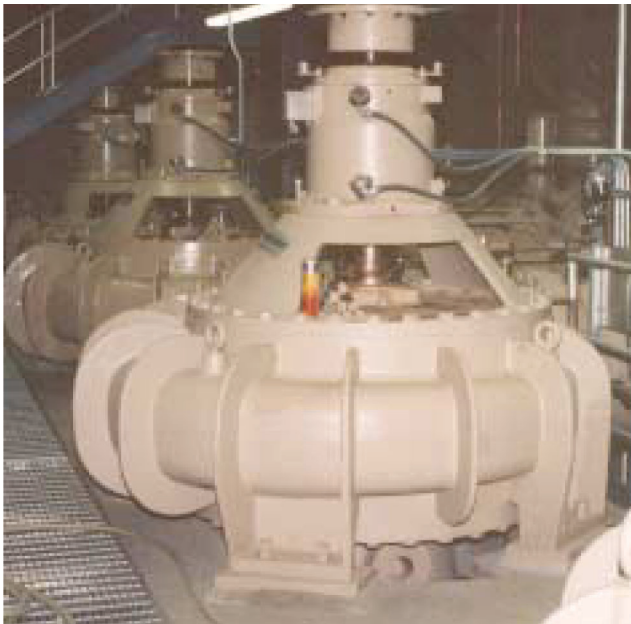

Figure 9. Vertical Long Shafted Nonclog Pump.

OPERATION

Collection Station

Small collection stations, less than 10 mgd, consist of two or more pumps with one pump acting as a standby. They are usually constant speed stations with the start/stop sequence set by the wet-well level. Large collection stations consist of three or more pumps with one pump acting as a standby. Large stations can also be constant speed with the start/stop sequence set by the wet-well

level. However in recent years it is more common for both small and large stations to match incoming and outgoing flow using variable speed pumping equipment.

Variable Speed Operation

When variable speed pumps are utilized it is recommended that at least two operational units be variable speed with a third unit being available for standby use. By doing this single pump operation back on the pump curve can be avoided. This is accomplished by starting the lead pump at its minimum flow rate speed and bringing it up to full speed as the station flow demand increases. With a further demand in flow rate a second variable speed pump is called to start and the lead pump is reduced in speed to match that of the second pump. Both pumps share the load and speed is increased with flow demand until maximum pump speed is reached. Additional pumping demand is then met with the constant speed pumps. The operating range of required pump flow versus TDH should be carefully reviewed with the pump supplier to assure that operation will be as stable as possible over the expected range of operation for each pump. The pump supplier will often ask for a system versus head curve for this purpose.

Variable frequency drives (VFD) are the most commonly used method for induction motor speed control. The input section of the VFD rectifies the AC power to DC and then the VFD recombines the power using a series of waveforms to vary the output frequency. Varying the VFD output frequency varies the attached induction motor speed whose output speed is proportional to the input (VFD output) frequency. An additional advantage of the VFD is that the line-side power factor can be maintained close to 1.0.

An eddy-current drive placed between the motor and pump can be used to vary the input speed to the pump. The eddy-current drive consists of an input and output rotor linked through magnetic coupling. The magnetic field strength is varied to control the slip between rotors. The input shaft rotates at the motor full load rpm and the output shaft speed is controlled by the amount of slip.

A wound rotor motor is an induction motor with a wound rotor. The rotor windings are connected to a slip ring and a variable resistance is attached to the static side of the slip rings. Slip and torque are controlled by varying the rotor winding resistance.

PUMP DESIGN ELEMENTS

Solid Size

Nonclog pumps are specified and sold on their ability to pass a maximum diameter sphere through the pump. A minimum 3 inch diameter sphere is accepted by many US states as standard. Experience indicates that a pump with a solids passing rating 4 inch diameter or larger will have much less tendency to clog on stringy trash (Benjes, et al., 2001). There are a number of places within the pump that the minimum diameter can occur such as the suction inlet, the impeller eye, between impeller vanes, and the casing throat.

Clogging Potential

Passing a solid through a pump is different from preventing clogging and the pump must be designed to do both. Rags and stringy materials like to catch on the suction vanes tips, obstruction in the impeller eye, and to a lesser extent on the casing tongue (cutwater). Also, hair, grit, and small fibrous materials tend to jam into areas with close running clearances such as wear rings and impeller shrouds.

Casing

Nonclog pumps are normally of the single-volute casing design with dual-volute casings used occasionally on larger high-head pumps to reduce radial load. Concentric or semiconcentric casing designs can be used on small high-head pumps to reduce radial loads on either side of the best efficiency point (BEP) and even out

radial loads across the performance curve. The use of a concentric or semiconcentric casing typically results in a reduction in pump efficiency. All casing designs must be provided with well rounded/blunt cutwaters to minimize clogging.

Impeller

Nonclog pump designs are available in specific speeds $N_s = 1500$ to 5000 with most designs in the range of $N_s = 2000$ to 3500 . Flows are available from 100 to $100,000+$ gpm, heads from 10 ft to 250 ft TDH, and synchronous shaft speeds from 300 to 2000 rpm. Most impellers fall into the mixed flow regime and are characterized by a wide discharge, large eyes, and as few blades as practical.

Number of Vanes

Minimizing the number of vanes increases the potential solid size rating by increasing the distance between blades and reducing the impeller eye blockage. By reducing the number of vanes the opportunity for clogging is also reduced. For example, a two vane impeller has two-thirds the opportunity for rags catching on the vanes as a three vane impeller per shaft revolution. In most cases reducing the number of vanes comes with cost. Minimizing the number of blades can affect pump performance through a reduction in pump efficiency, an increase in vane loading, an increase in the slope of the head-capacity curve, an increase in pressure pulsation, and an increase in torque pulsation. Therefore, nonclog pump impellers are designed with as few blades as practical to meet the specified conditions-of-service without excessive clogging.

Single Bladed Impeller

A single bladed impeller offers the lowest number of blades possible for conventional nonclog centrifugal impeller design. However, it is difficult to achieve balance of the impeller in operation since impellers are traditionally balanced dry and operate wet. When balancing dry there is no weight present for the off shaft center, center-of-gravity (cg) of the water mass within an operating single vane impeller. If the impeller is in balance dry, it will be out of balance in operation. Some manufacturers purposefully balance their single vane impellers with a specific imbalance designed to counteract the off shaft center cg of the impeller water mass. Therefore, single vane impellers should not be further recut to change performance without correctly adjusting the imbalance or significant vibration can result.

Impeller and Casing Multiplicity

Most manufacturers have multiple impeller designs for casings within their product line. This allows the manufacturer to meet different specified conditions with minimum capital investment. In addition, most nonclog impellers can be cut down to approximately 80 percent of their full diameter to meet a specific condition-of-service. When a system is designed for both present and future conditions-of-service the designer may be able to achieve both conditions using a combination of techniques. The existing condition may be met using a minimum diameter impeller and then installing a larger diameter impeller in the casing to meet the future conditions. Or future conditions may be met by installing a new higher capacity impeller in the existing casing. Motor bhp requirements and the impeller interface with other components such as the shaft, wear rings, and suction head must be considered.

Impeller Eye

The impeller eye design is constrained by the need to keep the impeller eye large to pass solids and at the same time keep it small to minimize loading and wear. A large eye minimizes clogging and net positive suction head required (NPSHR) and maximizes solid size capability. A large eye may also increase the casing or suction head size and decreases the impeller diameter available to trim. A

small eye minimizes axial load and impingement velocity at the outside diameter of the suction vane tips.

Attachment to Shaft

The attachment of the impeller to the shaft must be designed to prevent protrusions of sharp edges into the flow stream. A contoured impeller nut with a recessed fastener(s) works well. The mounting face of the nut on the impeller should be placed to prevent sharp intersection with the suction vane tips.

Wear Ring Design

A wear ring is used to supply a renewable gap at the intersection of the impeller with the casing. Nonclog pumps traditionally use only one set of wear rings located at the inlet eye to the impeller. High head pumps may use an additional set of back wear rings located on the rear shroud of the impeller to reduce the high axial loads caused by the higher pressures over the imbalanced areas. All wear ring designs for nonclog pumps should be of a smooth surface without irregularities for debris in the pumped liquid to catch or lodge.

Types and Location

Front wear rings come in axial and radial wear ring configuration. Axial wear rings place the wearing gap on a plane perpendicular to the shaft axis and protect the nose of the impeller from wear. The gap is normally adjustable using shims or jackscrews located exterior to the pressure containing parts. This allows the axial wear ring gap to be adjusted to compensate for wear and/or to clear clogged debris from the wear ring gap. Radial wear rings place the wearing gap parallel to the shaft axis and are available in the two basic types of straight and L-type rings. Radial wear rings are nonadjustable and the gap is controlled either by controlling the component tolerances or by manually setting the gap during installation of the pull-out assembly into the pump casing. L-type rings protect the nose of the impeller and suction head from wear and thereby offer a slight advantage over straight radial rings.

Flush Wear Rings

Pumping fluids with high concentrations of abrasives and/or small fibrous materials may require using clean water to flush the wear ring gap. If supplied, flush wear rings should be designed to provide a minimum of 6 fps of flow velocity toward the discharge from the wear ring gap. To achieve the desired flow the wear ring inner diameter (ID) gap will normally be tighter than that to the outer diameter (OD) gap (Figure 10).

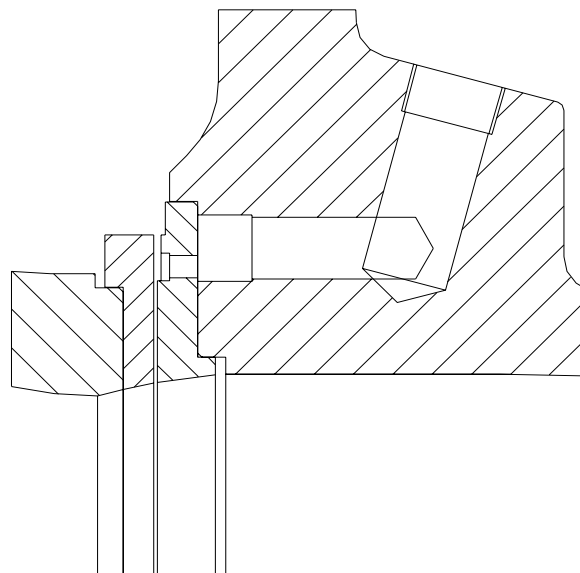

Figure 10. Flush Wear Ring Design.

Impeller to Casing Clearance

When nonclog pumps are shut down the heavier suspended solids settle to the lowest point in the pump. In many cases this point is the intersection of the front wear rings with the suction head or casing. Solids remaining in this area can be forced into the wear ring gap and cause accelerated wear of the rings and increased starting power. To promote solids removal when the pump is started the suction head (casing) should gradually slope to the volute for ramping and expulsion of these solids.

Stuffing Box Seals

Packing

The seal between the pump shaft and the stuffing box prevents the leakage of pumped fluid out of the pump. Nonclog pumps have traditionally used packing to seal this joint for reliability and ease of maintenance. Properly installed packing requires a small amount of leakage from the box to promote lubrication and cooling and in many cases this leakage from a nonclog pump is septic. To minimize septic leakage many operators overtighten the packing, which results in increased power usage, wear on the shaft sleeve, and premature packing ring failure. Properly tightened packing produces a trickle to stream of leakage from the top of the box.

Mechanical Seals

Mechanical seals have seen increased use in nonclog pumps in recent years due to the availability of reliable split mechanical seals. Mechanical seals produce little to no leakage and require little maintenance until they fail. When they fail the pump pull-out assembly must be removed to replace a conventional seal. Split mechanical seals do not require the removal of the pull-out assembly for replacement and have eliminated a major obstacle for the use of mechanical seals.

Mounting Mechanical Seals

Many mechanical seals are set-screw driven and cannot be reliably mounted to a hardened shaft sleeve due to the inability of the set-screw to “bite” into the sleeve. Sleeves for set-screw driven mechanical seals should be a soft corrosion resistant material such as 316 series stainless steel. Many mechanical seals have special machining requirements for the stuffing box and cannot be placed in a box designed for packing. Therefore, the choice of using packing or mechanical seals should be made before purchasing the pump or during a pump overhaul.

Seal Water Flow

Both packing and mechanical seals require seal water injection for flushing, heat removal, and lubrication. The injection port location for packing is usually into a lantern ring located in the center of the packing rings. In high grit service a second lantern ring may be used at the bottom of the box to allow direct flushing. Single mechanical seals use one injection port and double mechanical seals use two injection ports; one in and one out. Approximately 6 fps of flush water velocity into the pump through the close clearance portion of the stuffing box is recommended for packing and single seals to prevent the infiltration of grit into the stuffing box. This is approximately 1.2 gpm per inch of shaft sleeve diameter assuming a 0.040 inch diametric gap between the shaft sleeve and the stuffing box ID. Monitor seal water flow whenever possible using a small rotometer located at the injection port.

Seal Water Operation

The operating cycle of the seal water is important to maintain packing and mechanical seal life. When nonclog pumps are shut down suspended solids settle to the lowest point in the pump. During this settling the pumped fluid may try to extrude through pressure joints such as the stuffing box. If seal water flow is not

maintained until the solids settle out of solution, then grit may enter the stuffing box. To prevent the entry of grit into the stuffing box the seal water should be started before the pump is started and should remain on for two to three minutes after the pump is shut down. If the wet well level is above the stuffing box then the best protection against grit infiltration is to leave the seal water flow on.

Bearings

The bearings in a nonclog pump are expected to carry the pump hydraulic thrust and hydraulic radial load and both loads can be considerable. Radial loads are high due to the impeller being overhung on the shaft and the wide impeller width necessary to pass solids. Thrust loads are high due to the single suction design and a reluctance to use impeller back rings or back vanes. Most pumps are sized to produce a minimum 50,000 hr L-10 bearing life and many are sized for a much higher L-10 rating. The combination of high loads and a desire for a high bearing life considerably complicate the selection of nonclog pump bearings.

Hydrodynamic Bearings

Hydrodynamic bearings may be supplied in vertical nonclog pumps and are normally a plain journal bearing designed to carry radial load only. Thrust is transferred to the motor through rigid shafting and the motor thrust bearing is designed to carry the load. Each pump manufacturer designs and produces their own hydrodynamic bearings and spare parts are only available from the original equipment manufacturer (OEM). In years past oil lubricated hydrodynamic bearings were used extensively in large vertical nonclog pump applications. Except for duplicate or replacement pumps, their use in recent years has been mostly relegated to the water lubricated bearings in vertical turbine nonclog pumps due mainly to the limited availability of spare parts, the high cost associated with small production runs, and the fact that larger capacity antifriction bearings are now more readily available.

Antifriction

Antifriction bearings are the mainstay in modern nonclog pump bearings. They are widely available, relatively inexpensive, and, in many cases, sizes from one bearing manufacturer are interchangeable with those of another manufacturer. They are available in either a ball or roller bearing configuration and the choice of bearing design used is based on application and the preference/experience of the pump designer. Pump bearing selection begins with evaluating the pump design criteria and reviewing them against bearing characteristics (Table 1).

Table 1. Bearing Characteristics.

Bearing Type	Thrust Load		Radial Load Capability	Separable	Misalignment
	Capability	Direction			
Deep Groove Ball	Limited	Both	Good	No	Limited
Angular Contact Ball	High	Single	Good	No	Limited
Double Row Spherical Roller	Good	Both	High	No	Self Aligning
Tapered Roller	High	Single	High	Yes	Limited

Deep Groove Ball—Deep groove ball bearings are used primarily to carry radial loads but have the ability to carry limited thrust loads in both directions along the shaft. They are widely available and inexpensive. They can have a significant axial endplay that may affect the setting of an axial wear ring gap or the use of a mechanical seal with limited axial movement tolerance.

Angular Contact Ball—Angular contact ball bearings are used when there is need to carry radial and thrust load. They can only carry a thrust load in one direction along the shaft and require a separate bearing to carry thrust load in the reverse direction. They are often used in the dual paired configurations of back-to-back or face-to-face. The back-to-back configuration is a stiff bearing design capable of carrying tilting moments and is typical for off-

the-shelf double-row bearing configurations. The face-to-face configuration is a little more forgiving to angular misalignment than back-to-back but is less suitable for carrying tilting moments. It also must have its outer races firmly clamped to prevent excessive bearing clearances in operation. In addition to back-to-back and face-to-face arrangements, angular contact ball bearings can also be used in tandem or triplex configurations to carry heavier thrust loads. All angular contact ball bearings require a second bearing to carry thrust in the opposite direction and proper orientation of the individual bearings is critical at assembly.

Double-Row Spherical Roller—Double-row spherical roller bearings are used when high radial load carrying capability with or without moderate thrust capability in both directions along the shaft is required. They are self-aligning and can handle significant misalignment. However, their self-aligning capability combined with being nonseparable makes them more difficult to install.

Tapered Roller—Tapered roller bearings are used when both high radial and high thrust loads are required. The ability to carry both high radial and high thrust loads make them ideally suited for use in nonclog pumps. Tapered roller bearings are always used in pairs and the end-play between bearings must be set either manually or by using precision spacers.

Lubrication

Proper lubrication of antifriction bearings is crucial to their longevity. Most nonclog pump bearings are grease lubricated with oil lubrication occasionally used in horizontal configurations. Vertical nonclog pumps can be oil lubricated but often require the use of an external oil lubrication system. Oil lubrication requires special care in the design of bearing housing sealing at the shaft penetrations and a sight glass is usually provided to monitor oil level and oil quality. The ability to externally monitor the quality of the lubricant combined with good heat transfer capability gives oil lubrication an advantage over grease.

Grease is the most common lubricant for nonclog pump bearings because of its simplicity. Most nonclog pump bearings use a lithium-based NGLI #2 grease with an extreme pressure (EP) additive commonly used for roller bearings. The bearing temperature should be held below 180°F to avoid premature grease and bearing failure unless special high-temperature grease is used. All bearings must be regreased at periodic intervals whose length depends on bearing type and size, operating rpm, environmental conditions, and operating temperature. Care must be exercised when regreasing to avoid over filling the bearing, which can cause overheating and premature grease and/or bearing failure.

Proper control of the bearing environment is also crucial to bearing life. The bearing cavity must be maintained free of infiltration from moisture and dirt. Otherwise, the predicted bearing life may be drastically reduced (Marscher, 1999).

MATERIALS

As is the case for most pumps, many material combinations are available for use in nonclog pumps. Most materials that can be cast may be specified to meet specific requirements. However, the cost of nonstandard materials can be substantial and the user is cautioned to stick with standard materials or standard optional materials unless the need dictates otherwise. McCaul and Miller (2001) provide good insight into material selection on a broad basis and the reader is encouraged to review their text for specific applications.

Pressure Vessel

The pressure vessel consists of all the pressure containing stationary parts of the pump such as the casing, stuffing box head, and suction head. The standard material is grey cast-iron normally per ASTM A48 (or A278) in class 30 minimum. It offers good mechanical strength, good machinability, and low casting cost. Adding 1.5 to 3 percent nickel to the iron is probably the most

common optional material. Occasionally CF3M (316L) or Ni-resist are specified for corrosive environments but both add considerably to cost.

Impeller

The standard impeller material is grey cast-iron normally per ASTM 48 class 30. It offers good mechanical strength, good machinability, and low casting cost. Adding 1.5 to 3 percent nickel to the iron is probably the most common optional material. Occasionally chrome-iron per ASTM A532 may be used for extreme abrasive service; however it is difficult to machine due to its hardness. Chrome-iron is also brittle and is not a good choice for applications pumping the occasional hard solid that may break or chip the impeller leading and trailing edges. CA6NM and CF3M (316L) may be used both for corrosion and erosion/cavitation resistance and both are weld repairable (CA6NM before heat treating). Chrome-iron, CF3M, and CA6NM add considerably to cost.

Wear Ring

Wear rings are normally supplied in hardened 400 series stainless steel with the stationary ring 50 to 100 BHN (Brinell points) harder than the rotating ring to prevent galling. However, wear rings supplied above 400 BHN do not have to maintain the 50 to 100 BHN difference in hardness to prevent galling (McCaul and Miller, 2001). Abrasive services may be met using a high hardness coating such as ceramic but in the authors' experience these coatings may chip and flake off under grit "grinding" conditions. Corrosive services may be met using either bronze or CF3M but at the sacrifice of erosion capability. Additionally, the wear ring gap may have to be increased when using CF3M to avoid galling from ring contact.

Shaft Sleeve

The shaft sleeve is normally supplied in hardened 400 series stainless steel. Greater wear resistance may be met by using a high hardness coating such as ceramic. Corrosive services may be met using either bronze or CF3M but the box should be carefully packed and proper seal flow maintained to prevent undo sleeve wear. The user is cautioned against using a hardened shaft sleeve when mounting a mechanical seal since many seals are set-screw driven and the drive screws will not "bite" into a hardened sleeve.

Shaft

Shafts for dry-pit nonclog pumps are commonly made from either low carbon or alloy steel depending on strength requirements. Shafts for vertical turbine nonclog and submersible nonclog pumps are typically 400 series stainless steel. Corrosive service for all types may be met using 316, Nitronic® 50, or 17-4PH stainless steel depending on strength requirements. All three add considerably to cost.

DRIVERS

Electric motors are the most common driver for nonclog pumps with diesel engines occasionally provided. However, when diesel engines are used, special care must be taken to ensure that the rotor torsional natural frequencies are not excited in operation.

Induction Motor

Induction motors are the most commonly used motors due to their simplicity in form and operation, wide availability, and low first cost. They are available from fractional bhp to a practical limit in these applications of 3000 bhp and operate at a full load rpm less than synchronous speed. The motor speed is proportional to the input frequency and can be varied using a variable frequency drive. The motor inrush current is high when started across the line and its full load power factor is less than 1.0.

Synchronous Motor

Synchronous motors operate at a full load operating rpm equal to synchronous speed. They are started as a conventional induction motor and therefore have the same high inrush current when started across the line. When the motor is close to full load speed the windings are energized and the motor pulls into synchronous speed. Synchronous motors are used for large constant speed load applications in a range of 500 to 3000 bhp. Synchronous motors may be more expensive than induction motors but they operate at a power factor of 1.0 or greater and with proper sizing can significantly reduce the power cost for the entire plant. They are particularly advantageous in slow speed applications where induction motors typically have significantly lower power factors. Synchronous motors can be operated variable speed using a load commutated inverter (LCI) drive.

VIBRATION

Acceptance Criteria

Nonclog pump specifications typically reference ANSI/HSI Standard 9.6.4 (2000) to specify acceptable vibration limits. ANSI/HSI Standard 9.6.4 (2000) bases the allowable vibration level on the bhp produced during measurement and whether the pump is horizontally or vertically oriented. All measurements are unfiltered, root-mean-square (RMS) averaged, and vibration at the motor is not part of the specification. Allowable vibration levels measured at the pump bearing housing range from 0.22 to 0.34 ips zero-to-peak RMS unfiltered. These are reasonable vibration levels for the pump but vibration levels at the motor, which is normally a more expensive machine than the pump, have to be specified from a different source such as ISO 10816.

Lilly and Marscher (1998) have suggested a conservative approach to vibration acceptance testing based on vibration measurements not exceeding any of the following three vibration levels at any frequency: 2.0 mils peak-to-peak, 0.25 ips zero-to-peak, and 1.0 g peak. Applying the criteria to nonclog pumps seems acceptable except in the frequency range covered by vane pass frequency where the 2.0 mils peak-to-peak criterion may fail large slow speed pumps likely to give good service life. Applying a criterion of 0.25 ips zero-to-peak at vane pass frequency is more suitable.

Lilly and Marscher (1998) also recognize that the vibration at the top of a motor mounted to a tall vertical pump will be significantly higher than it is at the pump bearing frame due to rotation of the unit about the pump anchorage. Increasing the acceptance criteria based on a ratio of heights above the pump anchorage seems reasonable.

Vibration Diagnosis

Much has been written about the diagnosis of machinery vibration based on measurements of frequency, phase, and amplitude and it does not need repeating here. The reader is encouraged to review Table 22-1 of Lilly and Marscher (1998) for an excellent review of vibration troubleshooting tips targeted at pump vibration diagnosis.

Problem Sources

The three excitation frequencies of $1\times$, $2\times$, and vane pass can always be counted on to show up in the vibration spectra for properly designed nonclog pumps. $1\times$ shows up due to residual imbalance and coupling misalignment. $2\times$ shows up due to coupling misalignment and as the universal-joint coupling's excitation frequency. Vane pass shows up as a strong excitation due to the low number of vanes used. For example, a two vane 200 bhp machine produces 100 bhp from each blade and the blade passes the cutwater twice in a revolution. Pressure and torque pulsations are the result.

Nonclog pump impellers are run at full load speeds ranging from 360 rpm to 2000 rpm and the number of impeller vanes varies from

a minimum of one at 1800 rpm to a maximum of five or more in the larger low speed pumps. This can result in vane pass frequencies ranging from below 10 hz to over 60 hz. Unfortunately the majority of structural natural frequencies for vertical units will fall within this range. Combining the vane pass frequency excitation with $1\times$ and $2\times$ excitation produces a range of excitation sources that are difficult to avoid. The possibility of exciting a structural resonant frequency is very high, especially if the unit is variable speed.

UPFRONT VIBRATION ANALYSIS

An accurate upfront vibration analysis provides the best chance of not encountering vibration problems in the field that are in most cases difficult to correct and in all cases expensive to correct. Upfront vibration analysis consists of accurately predicting the natural frequencies and placing their occurrence at frequencies least likely to harm the equipment. Upfront analysis should only be performed by personnel experienced with what it takes to perform an accurate analysis. It does not make sense to spend money on an analysis that is not consistent with the field vibration measured simply because the analyst was not familiar with current techniques and/or methods. The following can be considered minimum analysis requirements:

- A structural natural frequency analysis should include the motor, pump, foundation, attached piping, and entrained water.
- A rotor lateral natural frequency analysis should include shafts, bearing stiffness, couplings, masses, inertias, and entrained water.
- A rotor torsional natural frequency analysis should include shafts, couplings, masses, and inertias for both the motor and pump.

Vertical Frame-Mounted

Vertical frame-mounted nonclog pumps have the largest potential for exciting a structural resonance. A structural lateral natural frequency analysis of the motor/pump assembly should be performed on all new designs that do not have a history of being sold and on all variable speed units larger than 100 bhp. The need for upfront vibration analysis work on constant speed units larger than 100 bhp should be determined by using the motor reed-critical frequency as a guide. Assume the mounted motor reed-critical frequency will be on the order of 50 percent of that calculated by the motor vendor and compare it to the excitation frequencies. Upfront analysis work on units less than 100 bhp may be more expensive than field fixes and therefore may not make economic sense for all applications. A torsional natural frequency analysis should be performed for all units.

Vertical Long-Shafted

Constant speed vertical long-shafted nonclog pumps have little possibility of exciting a structural natural frequency unless the pump or the motor is mounted to a nonrigid structure, which is quite often the case for the motors of these units. A structural lateral natural frequency analysis of the motor and/or the pump should be performed on all variable speed units larger than 100 bhp, and on all equipment not mounted to a rigid structure. The torsional natural frequencies of the entire drive train and the lateral natural-frequencies of the intermediate driveshaft should be calculated for all units.

Vertical Turbine Nonclog

Vertical turbine nonclog pumps have a large potential for exciting a structural resonance. A structural lateral natural frequency analysis of the motor/pump/column assembly should be performed on all units regardless of history. A torsional and lateral natural frequency analysis of the entire drive-train should be performed for all units.

Horizontal Units

Horizontal nonclog pumps have little possibility of exciting a shafting lateral natural frequency or a structural natural frequency unless they are not directly mounted to a substantial foundation or a variable speed drive is used. The only upfront analysis work typically required is to calculate the torsional natural frequency of the entire drive-train.

TYPICAL PROBLEMS AND SOLUTIONS

Table A-1 (please refer to APPENDIX A) lists symptoms, diagnoses, and solutions for typical problems seen with nonclog pumps excepting vibration, which is covered under the section entitled Vibration Diagnosis.

EQUIPMENT UPGRADES

Introduction

Water treatment plant personnel and their consultants face a long list of issues exacerbated by ever tightening environmental regulations. Just to mention a few:

- Plant capacity mismatched to base and peak loads
- Obsolete equipment
- Restricted funding
- Cannot shut the plant down to work on subsystems
- Unreliable equipment

How then can plant capacity be modified, and obsolete equipment modernized and upgraded with minimum expenditures all while operating the plant? In particular, how can nonclog pumps be upgraded? The answer is to specify the purchase and installation of modern pull-out-assemblies (POA) and upgrades one pump at a time. The POA consists of the pump bearing frame, shaft, impeller with wear rings, and the stuffing box. Okay, sounds easy but:

- Our pumps are 70 years old! Surely they need to be replaced.
- We have built the plant around the pumps so now we would have to demolish walls, conduits, ventilation ducts, and floors just to gain access.
- We need to increase pump flow by 50 percent, so we must need new pumps.
- All of the patterns for my pumps have been destroyed. It will cost too much to make a POA.
- Our pumps were manufactured by “XYZ Pump Co.” who no longer is in the business.
- We need VFDs but who would handle the torsional and lateral critical frequency issues?

Answers to these questions and more:

How Old is too Old?

The age of a pump has little bearing on the application of a POA to upgrade it. In fact, the older volute designs are, in many cases, a true involute spiral not a modern shape that has been squeezed to minimize cost at the expense of pump efficiency. This means that the distance from the centerline of the suction to the centerline of the discharge is greater in older pumps than in their modern counterparts. This fact adds cost to complete pump replacement because the piping must be demolished and reconstructed to adapt the modern dimensions.

Recent experience suggests that large sewage pump casings have very long service lives. In fact, the older units exhibit much less wear, as a percentage of original wall thickness, than modern pumps. There are two reasons for this observation. Competition has forced pump designers to increase flow velocity while reducing casting wall thickness. Simply stated, high fluid velocity (with

suspended abrasive solids) combined with thin casing sections, means shorter casing life. Wear in sewage pumps is generally limited to rings, bearings, and impellers.

Fitness-for-Use Inspection

When a pump upgrade is being considered, a fitness-for-use inspection should be conducted (Figure 11). These inspections should include an ultrasonic thickness test of the casing at known wear locations along with a visual check of suspect areas and the volute cutwater. In unusual cases, some wall thickness reduction is observed but the pump OEM can calculate the “retiring” thickness in a specific example that usually results in many additional years of pump life. Casing cutwater wear can be repaired by field machining the case to accept a fabricated cutwater extension. In situations where casing locating fits have worn the mating parts may be assembled, adjusted for internal alignment, then taper doweled into position.



Figure 11. Fitness for Use Inspection.

Changing Performance

Treatment plants that are faced with the need to increase or reduce pump flow can also use the POA technique on existing casings. Volute pumps in the specific speed range normally associated with sewage pumps are surprisingly insensitive to volute to impeller match. To appreciate this, review a manufacturer’s catalog performance curves and you should find that a particular pump model (size) shows several different performance curves for different impeller designs in the same casing. For example, one manufacturer catalogs nine different impeller hydraulic designs for one volute design! Using a POA with a new or different impeller than the original may allow the performance to be changed and the equipment life to be extended.

POA or New Pumps?

Once the decision to upgrade a pump or set of pumps is made, an assessment of the site conditions must be made.

In many cases pumps in the lower levels of the plant cannot be removed without total demolition of a building. In a large wastewater treatment plant in New Jersey, the five 42 inch discharge primary effluent pumps are installed in a long straight line, up against the wet well. There is access to the pumps on the opposite side of the room but the walkway is not as wide as the pump casing. Since the access hatch is located at one end of the line of pumps, there is no way to replace the last casing without removing the first four pumps (Figure 12). Of course, that would mean shutting down the entire plant for months—not an option. On the other hand, a POA is typically less than 30 percent of the width of an entire pump so it may be transported through tight spaces.



Figure 12. Tight Quarters.

In many plants a complete pump could be lifted directly up from its installed position if it were not for the walkways, ventilation ducts, power conduits, and other such obstacles built above it (Figure 13). In some cases even the pump drive equipment must stay in place while a POA is exchanged.



Figure 13. Overhead Obstacles.

In a Midwestern wastewater treatment plant, a large storm water pump that was constructed in 1931 was successfully upgraded with a modern POA and shafting. This work was accomplished under the existing drive motor since the owner was concerned that removal of the motor might result in its destruction.

Economic Considerations

A key feature of a POA-based pump upgrade is that it is made from components in everyday use. Pattern equipment, machining fixtures and methods, and the efficiency of volume production help reduce costs. Typically a special shaft is furnished along with a custom designed casing head or cover to adapt the new components to the existing casing.

Even when the OEM is no longer able to furnish pump components at a competitive price these adaptations can be made. Field verification of several critical dimensions of the existing casings is all that is necessary to provide the design inputs to make the adaptation.

Typically a POA based pump upgrade eliminates or minimizes costs in the following areas:

- Demolition of existing pumps.
- Piping modifications.

- Structural modifications.
- Site labor.
- Design fees associated with the above.
- Temporary pumping.

Since a POA-based upgrade can be accomplished in a matter of hours rather than weeks for a new pump installation station, shut downs can be avoided. In critical situations, the dismantling of an operating pump may be delayed until the POA is onsite and weather conditions are suitable for a pump outage.

Drive Upgrades with POA Application

There is no better time to implement a drive upgrade than when a POA application is planned. The pump manufacturer can be directed to coordinate the VFD, motor, foundation, couplings, and shafting just like it is commonly done on new pump installations. All the features of a new construction contract may be obtained with this course of action. In particular, assembly and installation drawings can be submitted for approval along with guaranteed performance curves. The torsional and lateral natural frequency calculations necessary to ensure proper vibration levels can be provided by the pump manufacturer when new motors and shafting are furnished with the POA. Add to this the assumption of responsibility for a complete functioning pump and drive system and the owner reaps the benefit of a new installation at a fraction of the cost.

POA CASE STUDY

A large wastewater treatment plant in New Jersey has operated its three 36 inch discharge raw sewage pumps since their installation in 1950. As shown in Figure B-1 (please refer to APPENDIX B), some of the obsolete features are:

- A. Babbitt sleeve bearing in spherical seat.
- B. Rigid line shaft.
- C. Forged couplings with fitted bolts.
- D. Soft shaft sleeves.
- E. Soft wear rings.

The plant decided that the pump was becoming too expensive to maintain and decided to investigate the POA upgrade technique. The casing inspection showed that the pump handles very little abrasive material and that no casing repairs were necessary. Since the impeller had been recently renewed the authority desired that it be reused with the modernized POA.

An engineering review of the modern design and the existing pump showed that the POA technique was the proper approach to the upgrade. As shown in Figure B-1 (please refer to APPENDIX B), the modern features include:

- F. Thrust and line taper roller bearings.
- G. Heat treated shaft sleeve.
- H. Adjustable face wear rings.
- I. Modern flexible shafting without fitted bolts.
- J. A new stuffing box head adapting the modern bearing frame to the existing casing.

As the POA was being manufactured it was discovered that the plant's overhead crane was unable to lift the weight of the subject pump's driving motor. Fortunately, the POA plan allowed the pump and shaft work to proceed with the motor remaining in place (Figure 14).

CONCLUSION

Nonclog pumps see use in many applications and represent one of the largest market segments available. Their application and maintenance require a proper understanding of the underlying



Figure 14. New POA in Place.

design issues associated with their use. Hopefully the reader is now cognizant of these design issues and will be able to apply them to the underappreciated, inglorious workhorse of our domestic wastewater system. Without them we would be up to our ears in, well, let's say alligators.

NOMENCLATURE

ANSI	= American National Standards Institute
BEP	= Best efficiency point. The point on the pump curve corresponding to peak pump efficiency.
BHN	= Brinell hardness number
cg	= Center of gravity
Close-coupled	= Pump with impeller mounted on the motor shaft.
COS	= Condition of service. The operating point on the pump curve represented by flow, head, and rpm.
Dry-well	= A below ground pit in which pumping equipment is mounted in a normally dry environment. Used in conjunction with a wet-well.
HI	= Hydraulic Institute
Overhung impeller	= Impeller located outboard of the bearings.
POA	= Pull-out assembly. Pump assembly consisting of the pump rotating components and the stationary components used for their mounting, i.e., shaft, bearings, shaft sleeve, impeller, stuffing box head, bearing frame, bearing frame covers, etc.
Rotating assembly	= Pump assembly consisting of the pump rotating components, i.e., shaft, bearings, shaft sleeve, impeller.
Specific speed	= A dimensionless number representing the hydraulic design type of the pump. Simplistically, a low specific speed represents low flow and high head and a high specific speed represents high flow and low head.

System versus head curve = A curve(s) of system resistance (TDH) versus flow. Where the system versus head curve crosses the pump curve is the point of pump operation. The system resistance consists of piping losses, form losses (elbows, valves, etc.), and static head (height of water above or below pump)

TDH	= Total dynamic head
VFD	= Variable frequency drive
VTP	= Vertical turbine pump
Wet-well	= A below ground pit with or without pumping equipment used to collect pumpage prior to processing.

APPENDIX A

Table A-1. Typical Problems and Solutions.

Problem	Symptom	Diagnosis	Solution
Ring binding	Pump stalls Pump won't start	Rotor will not turn by hand No blockage in impeller Rotor turns free after clearing rings.	Fill all ring retaining screw heads with Devcon Increase ring gap Implement ring gap flushing Increase driver torque
Impeller Eye clogging	Reduction in flow. Increased vibration and/or noise	Remove hand-hole cover and inspect impeller eye.	Remove any discontinuities in impeller eye and impeller retaining screw. . Change operating sequence. Operating the pump near shutoff for a short period of time to induce recirculation and clear the eye. Increase closing time of discharge check valve to allow back flow through the pump which will clear the eye at shut down.
Abrasive wear	Erosion on pressure side of vane and casing cutwater	Components look like they have been scoured	Coat repairable components with Devcon in areas of wear Replace with a more durable material
Low NSPHA	Continuous rock tumbling noise Less TDH than expected Less Power draw than expected	Review of NPSHA vs. NPSHR shows pump has insufficient NPSHA Closing discharge valve reduces noise Increasing wet well level reduces noise. For severe lack of NPSHA, inspection of impeller shows cavitation damage on non-pressure side of vane.	Increase the wet well level Restrict single pump operation to portions of pump curve where NPSHR are met. Use new material for impeller to allow operation if TDH can be met Use an impeller with lower NPSHR
Operation in Recirculation	Discontinuous rock tumbling noise that comes and goes.	Review of NPSHA vs. NPSHR show pump has sufficient NPSHA Opening discharge valve reduces noise (suction recirculation) For severe recirculation, inspection of impeller shows cavitation like damage on pressure side of vane.	New material for impeller to allow operation Use an impeller with different recirculation characteristics
Bearings Overheat	Bearing frame hot with temperature above 160°F	Grease is black/burnt Grease is liquefied and pours out frame when grease plugs are removed Grease has impurities Check bearing rollers and cages for wear	Repack bearings and do not over grease Replace bearings Remove grease plugs after re-greasing and run pump until excess grease is purged to ensure bearings are not over greased.
Short Packing Life	Packing replaced frequently	Packing is burnt Shaft sleeve is damaged	Repack box and replace sleeve Tighten packing gland to provide trickle of water from stuffing box. Ensure that 1.2 GPM of flush water is provided to each inch of shaft sleeve diameter
Power Consumption High	Power use exceeds that shown on the pump curve	Check power meter calibration and power calculation Check TDH and flow against curve Check for free turning rotor Check for tight packing Check for bound wear rings Check for bad bearings	Replace/or repair components

APPENDIX B

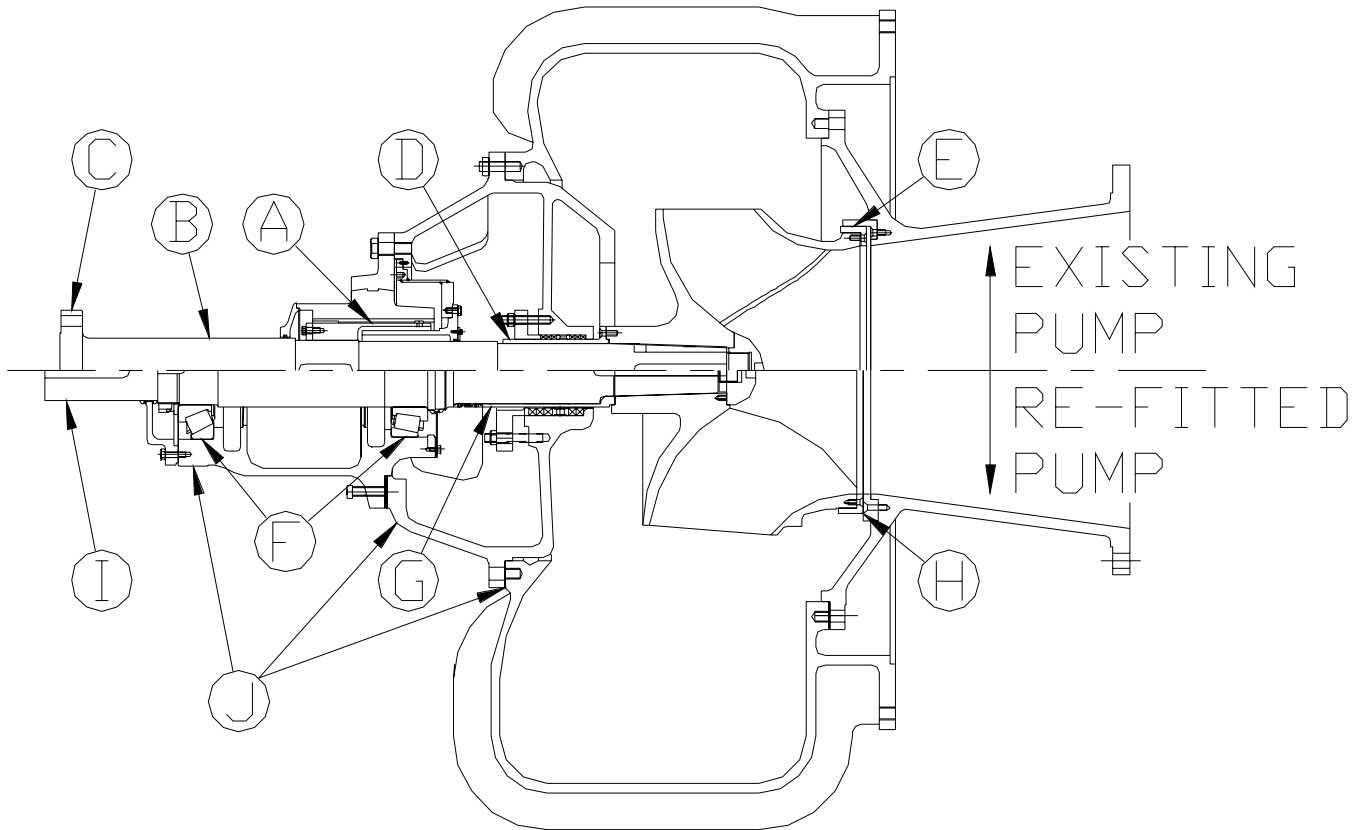

Figure B-1. Case Study New/Existing Pump Drawing.

REFERENCES

- ANSI/HI Standard 1.3, 2000, "Centrifugal Pumps for Design and Application," Hydraulic Institute, Parsippany, New Jersey.
- ANSI/HI Standard 9.6.4, 2000, "Centrifugal and Vertical Pumps for Vibration Measurements and Allowable Values," Hydraulic Institute, Parsippany, New Jersey.
- Benjes, H., Foster, W., and House, D., 2001, Section 9.2, *Pump Handbook*, Ed. I. Karassik, J. Messina, P. Cooper, C. Heald, New York, New York: McGraw-Hill.
- Bosserman, B. and Behnke, P., 1998, "Selection Criteria for Wastewater Pumps," *Water Engineering & Management*.
- Lilly, R. and Marscher, W., 1998, Chapter 22, *Pumping Station Design*, Ed. R. Sanks, Woburn, Massachusetts: Butterworth-Heinemann.
- Marscher, W., 1999, Chapter 4, *Modern Marine Engineers Manual*, Ed. E. C. Hunt, Centreville, Maryland: Cornell Maritime Press.
- McCaul, C. and Miller, R., 2001, Section 5.1, *Pump Handbook*, Ed. I. Karassik, J. Messina, P. Cooper, C. Heald, New York, New York: McGraw-Hill.

BIBLIOGRAPHY

SKF, 1991, *General Catalog*, USA: Command Web.